

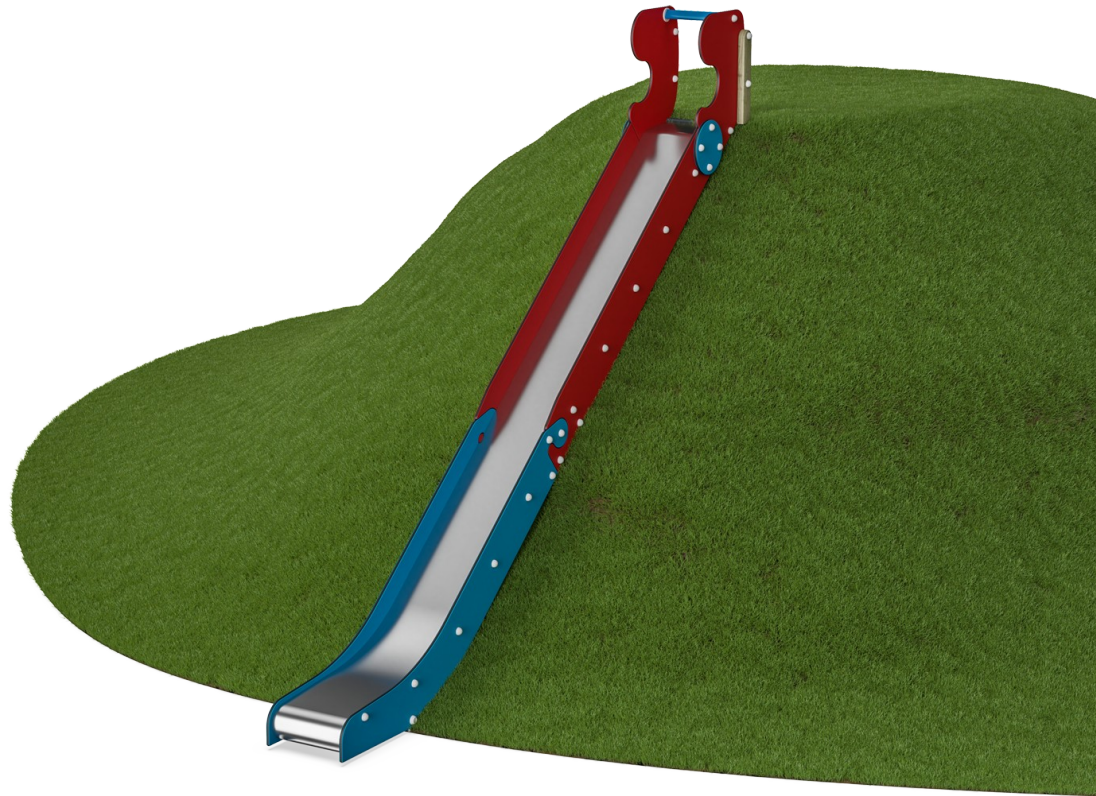

Embankment Slide, long

M385



Item no. M38570-3418P	
General Product Information	
Dimensions LxWxH	61x407x67 cm
Age group	3+
Play capacity (users)	3
Color options	



WOW! The long, classic KOMPAN embankment slide invites fun play activity for all children and those childish at heart. On the embankment run loop, children will run up and slide down again and again. Sliding on the embankment slide is an extra fun experience, as friends can run up or down next to their friends who are using the slide. There is room

for many and for different ages and abilities. The embankment hill is a great place for rolling or running, too. This is fun, playful cardio training for children. When children slide, they are training their core muscles, sitting upright while rolling down. This stimulates trunk stability, important for avoiding back and neck pains, a growing problem in children due to

increasingly sedentary lifestyles. Running uphill or downhill, children train their balance and coordination as well as their muscle strength. They develop risk management skills, too, holding back or letting go downhill.

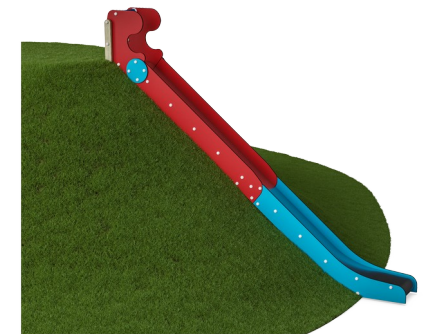

Embankment Slide, long

M385



Panels of 19mm EcoCore™. EcoCore™ is a highly durable, eco friendly material, which is not only recyclable after use, but also consists of material produced from +95% recycled post consumer material from food packing waste.

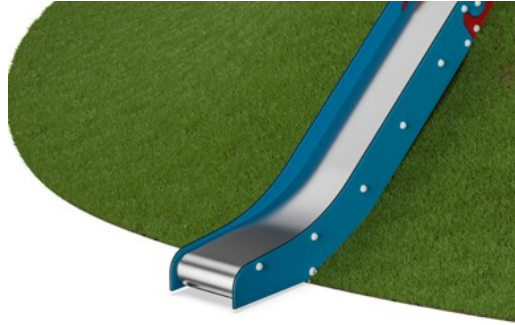

The stainless-steel slides with one-piece slide bed are made of high-quality stainless-steel AISI 304.



Handle is made of polypropylene PP with excellent impact strength and usable within a large temperature span.

Item no. M38570-3418P

Installation Information

Max. fall height	100 cm
Safety surfacing area	19.0 m ²
Total installation time	4.9
Excavation volume	0.27 m ³
Concrete volume	0.00 m ³
Footing depth (standard)	61 cm
Shipment weight	219 kg
Anchoring options	In-ground ✓



Sustainability Data

M385

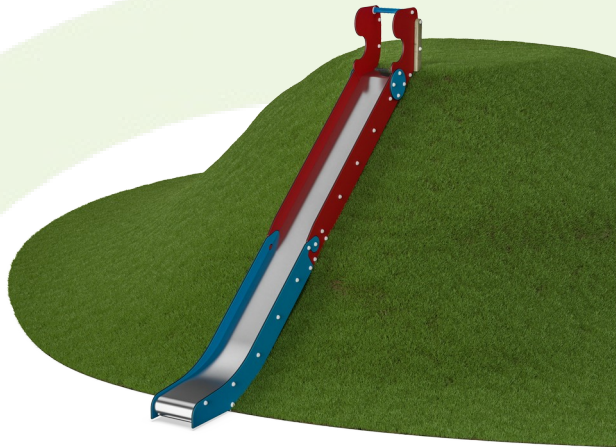

Cradle to Gate A1-A3	Total CO ₂ emission	CO ₂ e/kg	Recycled materials
	kg CO ₂ e	kg CO ₂ e/kg	%
M38570-3418P	383.80	2.44	63.70

The overall framework applied for these factors is the Environmental Product Declaration (EPD), which quantifies "environmental information on the life cycle of a product and enable comparisons between products fulfilling the same function" (ISO, 2006). This follows the structure and applies a Life-Cycle Assessment approach to the entire Product stage from raw material through manufacturing (A1-A3))

Kompan A/S
 C.F. Tietgens Boulevard 32C
 DK-5220 Odense SØ
 Denmark



Verification of CO₂ calculation of: Freestanding play equipment



Data version no. 2023-10-05

The CO₂ calculation and data are in compliance with the principles of a carbon footprint impact according to the GHG protocol (Greenhouse Gas Protocol), Scope 3, cradle to gate related to all individual components in the product category: "Freestanding play equipment" represented by item no.: GXY916012-3417.

(Scope 3 emissions include emission sources in the upstream and downstream value chain).

Date: 30. October 2023 | Valid until: 30. October 2025

Verified by:

Julie Marie Vejsgaard Larsen, LCA & EPD Consultant

Verification based on report: Validation of CO₂ calculation of 9 categories of Kompan product line, version 1.0, prepared by: Bureau Veritas HSE, Denmark: Julie M. V. Larsen.

Publication date: 30. October 2023

By Bureau Veritas HSE
 www.bureauveritas.dk
 +45 7731 1000



Embankment Slide, long

M385

* Max fall height | ** Total height | *** Safety surfacing area

* Max fall height | ** Total height

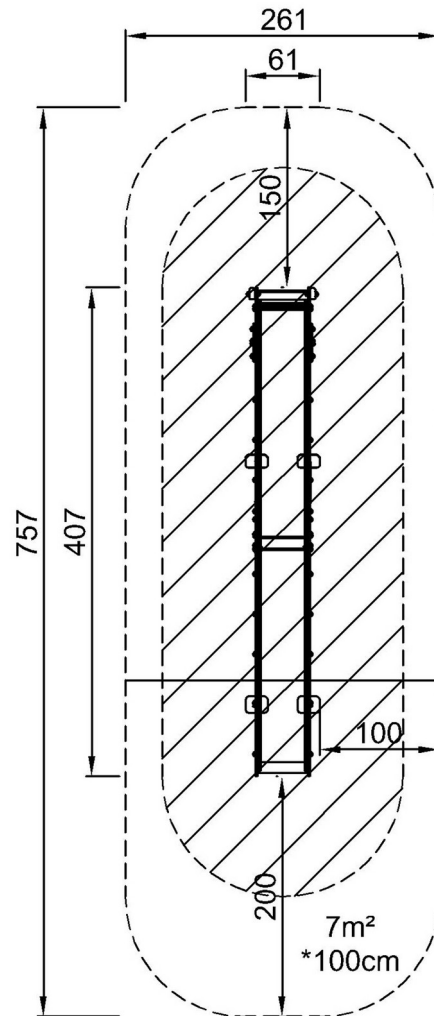

M38570
*100cm
**67cm
***19m²

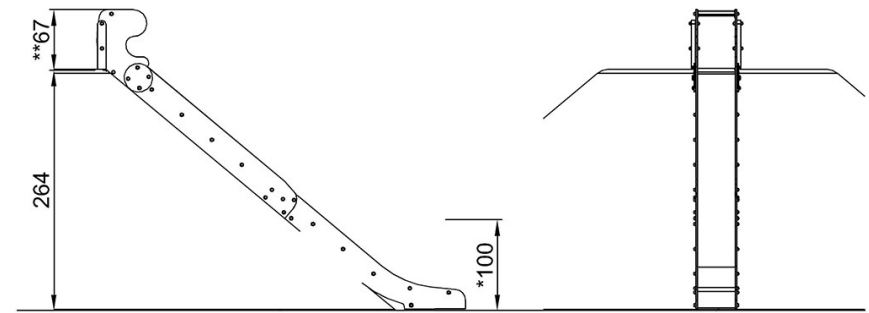

M38570

[Click to see TOP VIEW](#)

[Click to see SIDE VIEW](#)