

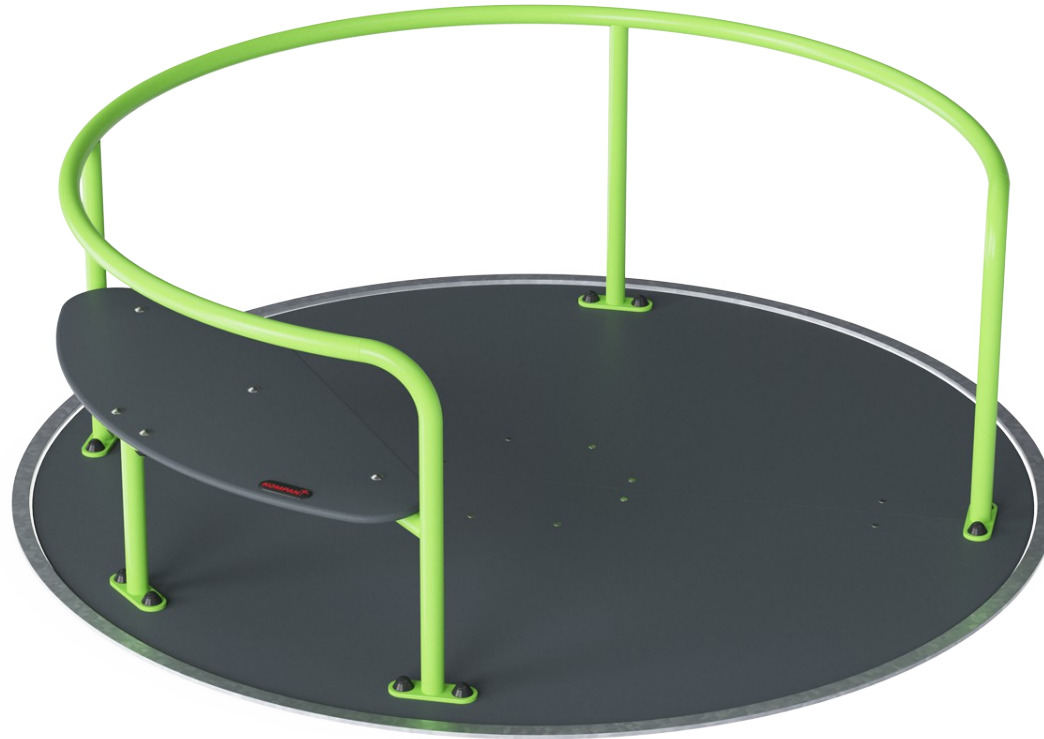

# Universal Carousel

PCM157



Item no. PCM157-0205	
<b>General Product Information</b>	
Dimensions LxWxH	208x208x70 cm
Age group	2+
Play capacity (users)	8
Color options	

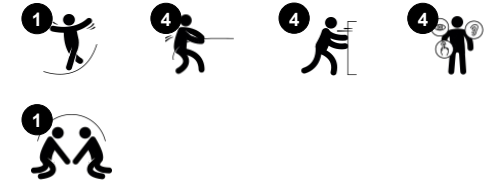

WOW – this is play for everyone, no matter their abilities. The huge truly inclusive, universal design carousel attracts big groups of children and adults in for a spin. Due to its versatility, it appeals to children and adults again and again. The ground-level design makes the carousel accessible to everyone. The bench provides a comfortably seated spin.

The handholds function from both sides. From the inside they offer good support, whilst from the outside they to get the carousel moving. Spinning on this carousel trains the vestibular system, the sense of balance and the spatial awareness. The benefits trained through play also encompass social skills, such as cooperation and empathy by assisting friends

of all abilities to spin and helping others wanting to join or exit. It is play with a purpose for all.



# Universal Carousel

PCM157



## Handrails and side poles

**Physical:** pushing or pulling the carousel strengthens arm and leg muscles. **Social-Emotional:** pushing and pulling others facilitates cooperation and empathy: when to stop, how to take turns etc.

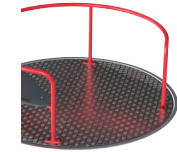
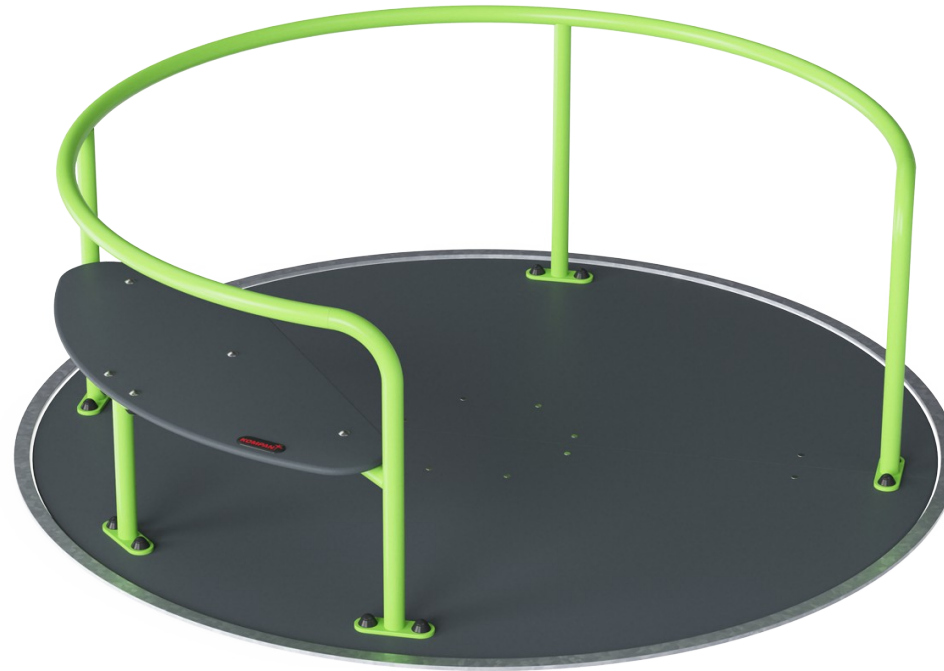

## Wide open entrance

**Physical:** enough space for securely jumping on and off while spinning, training agility, balance and coordination, as well as building bone density. **Social-Emotional:** allows space for assistive devices and wheelchairs.

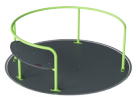

## Rotation

**Physical:** pushing or pulling it into motion, children use their muscle strength and strengthen their cardio. The rotation develops the sense of balance and space when enjoying the ride. **Social-Emotional:** listening and negotiating how slow or fast to go, children develop their empathy and cooperation skills.



## Bench

**Social-Emotional:** a secure resting point for less confident or physically agile users. Great point for adult users or assistants. The bench is placed to ease entry/exit.



## Carousel floor

**Social-Emotional:** room for many users, with or without assistive devices, to spin and play together. Training of cooperation and empathy.

# Universal Carousel

PCM157



Heavy duty designed welded carousel chassis of square steel pipes. The steel surfaces are hot dip galvanized inside and outside. The galvanization has excellent corrosion resistance in outside environments and is maintenance free.



The metal parts are made of high quality steel, hot dip galvanized inside and outside with lead free zinc. On the outside, there is an additional layer of powder coating. This ensures both excellent corrosion resistance and colorful design expression.

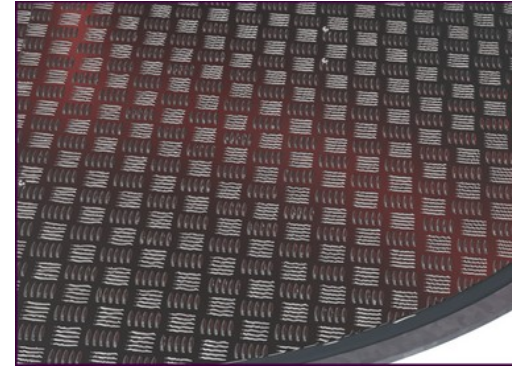

Deck plate of 3mm thick non skid aluminum or 17,8mm thick HPL plate. For warm locations KOMPAN recommends HPL deck plate as the aluminum will get hot in sunny conditions. Both deck plates ensures safe play for all users and is maintenance free.



Seat is made of HPL with a thickness of 17.8mm with a very high wearing strength and a unique KOMPAN nonskid surface texture.

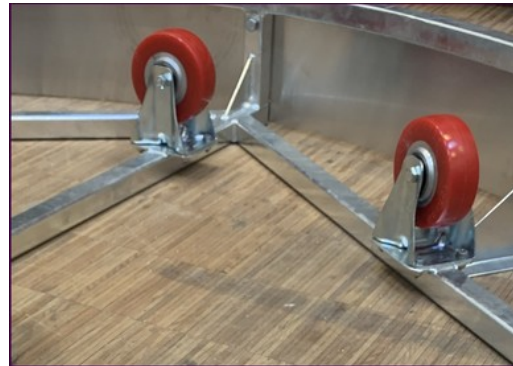

The roller system is designed with a fully closed lifetime lubricated center bearing supported by 10 wheels with a diameter of 125mm. The outer wheels ensures a smooth rotation under heavy load.



The outside hot dip galvanized steel ring makes a clear indication where the rotation deck begins. To ensure accessibility it is highly recommended to use rubber surfacing in the use zone around the carousel.

Item no. PCM157-0205

## Installation Information

Max. fall height	100 cm
Safety surfacing area	29.1 m <sup>2</sup>
Total installation time	6.3
Excavation volume	2.32 m <sup>3</sup>
Concrete volume	0.62 m <sup>3</sup>
Footing depth (standard)	37 cm
Shipment weight	406 kg
Anchoring options	In-ground ✓

## Warranty Information

Aluminium deck	15 years
Bearing construction	5 years
Hot dip galvanised steel	Lifetime
HPL seat	15 years
Spare parts guaranteed	10 years



# Sustainability Data

PCM157

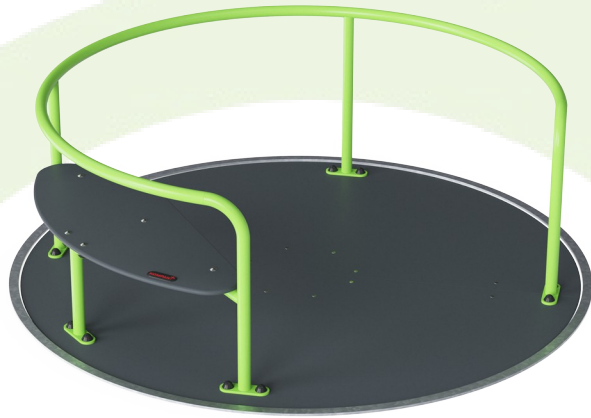

Cradle to Gate A1-A3	Total CO <sub>2</sub> emission	CO <sub>2</sub> e/kg	Recycled materials
	kg CO <sub>2</sub> e	kg CO <sub>2</sub> e/kg	%
<b>PCM157-0205</b>	629.43	2.75	27.06

The overall framework applied for these factors is the Environmental Product Declaration (EPD), which quantifies "environmental information on the life cycle of a product and enable comparisons between products fulfilling the same function" (ISO, 2006). This follows the structure and applies a Life-Cycle Assessment approach to the entire Product stage from raw material through manufacturing (A1-A3))

**Kompan A/S**  
C.F. Tietgens Boulevard 32C  
DK-5220 Odense SØ  
Denmark



## Verification of CO<sub>2</sub> calculation of: Freestanding play equipment



Data version no. 2023-10-05

The CO<sub>2</sub> calculation and data are in compliance with the principles of a carbon footprint impact according to the GHG protocol (Greenhouse Gas Protocol), Scope 3, cradle to gate related to all individual components in the product category: "Freestanding play equipment" represented by item no.: GXY916012-3417.

(Scope 3 emissions include emission sources in the upstream and downstream value chain).

**Date: 30. October 2023 | Valid until: 30. October 2025**

Verified by:

Julie Marie Vejsgaard Larsen, LCA & EPD Consultant

Verification based on report: Validation of CO<sub>2</sub> calculation of 9 categories of Kompan product line, version 1.0, prepared by: Bureau Veritas HSE, Denmark: Julie M. V. Larsen.

**Publication date: 30. October 2023**

By Bureau Veritas HSE  
www.bureauveritas.dk  
+45 7731 1000



# Universal Carousel

PCM157

\* Max fall height | \*\* Total height | \*\*\* Safety surfacing area

\* Max fall height | \*\* Total height

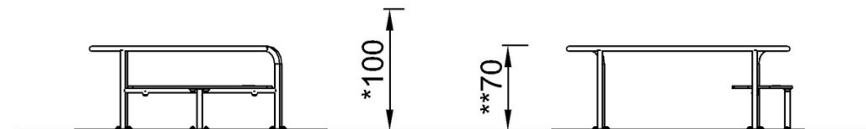
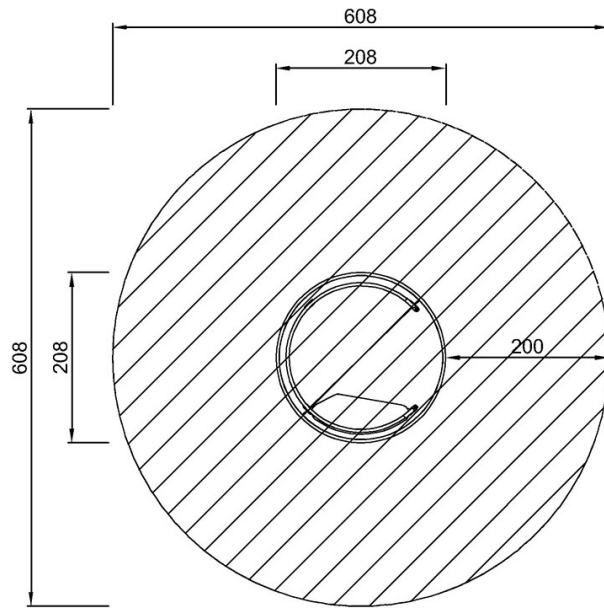

PCM157

PCM157  
\*100cm  
\*\*70cm  
\*\*\*29.1m<sup>2</sup>

[Click to see TOP VIEW](#)

[Click to see SIDE VIEW](#)