



Water Channel with Splash Table

NRO508



| Item no. NRO508-0601 | |
|-----------------------------|---|
| General Product Information | |
| Dimensions LxWxH | 137x317x107 cm |
| Age group | 2+ |
| Play capacity (users) | 13 |
| Color options |   |

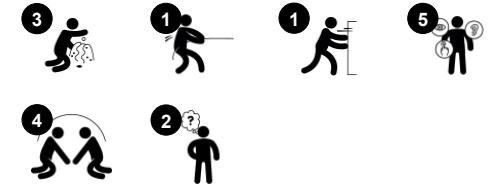

The Water Channel with Splash table is a fantastic attraction in the playground, keeping children absorbed in explorative play for hours. The combination of the splash table and water channel accommodates a lot of children in play at the same time. The open design allows for eye contact, cooperation and negotiation across the play piece, stimulating social-

emotional skills as well as communication and cognitive skills. The splash table can hold materials, and the angled water migrant can transport them to the table. This explorative play holds a multitude of opportunities for creativity and logical thinking, all stimulating children's cognitive-creative development. Take the water tap: when pushed, water streams,

when you let go it stops. This is fundamental for understanding e.g. object permanence.



Water Channel with Splash Table

NRO508



Water tap

Social-Emotional: develops turn-taking and cooperation when helping get water. Opens when pushed with hand, elbow, foot, chin or shoulder. Placed to also be reachable from a seated position. **Cognitive:** supports cause and effect understanding and logical thinking when figuring out how to push for water and let go for stopping the water stream. **Creative:** changing the amounts and sequences of the water flow.



Splash table with plug

Social-Emotional: meeting point for cooperation and sharing. Develops turn-taking and cooperation. **Cognitive:** logical thinking and understanding of cause and effect are trained when children stop or let go of water from the basin. **Creative:** the water plug makes changing water levels possible, which adds to logical thinking skills.



Water channel

Social-Emotional: children cooperate and communicate from both ends when running water through the channel. **Cognitive:** supports logical thinking and cause and effect understanding when children wait for the water to run through.



Lower platform

Physical: climbing up, jumping down develops muscle and motor skills such as coordination, which are important in navigating your body securely through the world. **Social-Emotional:** children can sit and talk together. The step helps children who need extra height to maneuver the tap and water channel.

Water Channel with Splash Table

NRO508



All Organic Robinia products by KOMPAN are made of Robinia wood from sustainable European sources. On request it can be supplied as FSC® Certified (FSC® C004450).

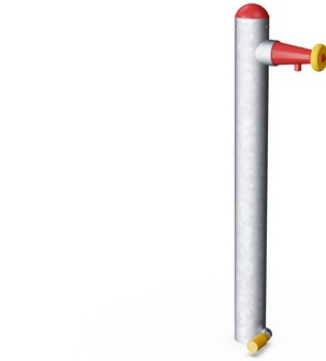

The steel surfaces are hot dip galvanised inside and outside with lead free zinc. The galvanisation has excellent corrosion resistance in outside environments and requires low maintenance.

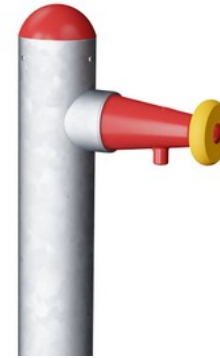

Play activities like the Megaphone are made of injection moulded high quality nylon (PA6). PA6 has good wearing and impact strength and is UV stabilised.



The Robinia wood can be supplied as untreated raw wood or painted with a brown coloured transparent pigment that maintains the golden wood colour of the wood.

| Item no. NRO508-0601 | |
|--------------------------|---------------------|
| Installation Information | |
| Max. fall height | 0 cm |
| Safety surfacing area | 22.9 m ² |
| Total installation time | 5.5 |
| Excavation volume | 0.57 m ³ |
| Concrete volume | 0.00 m ³ |
| Footing depth (standard) | 64 cm |
| Shipment weight | 278 kg |
| Anchoring options | In-ground ✓ |



Sustainability Data

NRO508



| Cradle to Gate A1-A3 | Total CO ₂ emission | CO ₂ e/kg | Recycled materials |
|----------------------|--------------------------------|-------------------------|--------------------|
| | kg CO ₂ e | kg CO ₂ e/kg | % |
| NRO508-0601 | 144.56 | 0.65 | 8.50 |

The overall framework applied for these factors is the Environmental Product Declaration (EPD), which quantifies "environmental information on the life cycle of a product and enable comparisons between products fulfilling the same function" (ISO, 2006). This follows the structure and applies a Life-Cycle Assessment approach to the entire Product stage from raw material through manufacturing (A1-A3))

Kompan A/S
 C.F. Tietgens Boulevard 32C
 DK-5220 Odense SØ
 Denmark



Verification of CO₂ calculation of: Nature play



Data version no. 2023-10-05

The CO₂ calculation and data are in compliance with the principles of a carbon footprint impact according to the GHG protocol (Greenhouse Gas Protocol), Scope 3, cradle to gate related to all individual components in the product category: "Nature play" represented by item no.: NRO409-0621.

(Scope 3 emissions include emission sources in the upstream and downstream value chain).

Date: 30. October 2023 | Valid until: 30. October 2025

Verified by:

Julie Marie Vejsgaard Larsen, LCA & EPD Consultant

Verification based on report: Validation of CO₂ calculation of 9 categories of Kompan product line, version 1.0, prepared by: Bureau Veritas HSE, Denmark: Julie M. V. Larsen.

Publication date: 30. October 2023

By Bureau Veritas HSE
 www.bureauveritas.dk
 +45 7731 1000



Water Channel with Splash Table

NRO508

* Max fall height | ** Total height | *** Safety surfacing area

* Max fall height | ** Total height

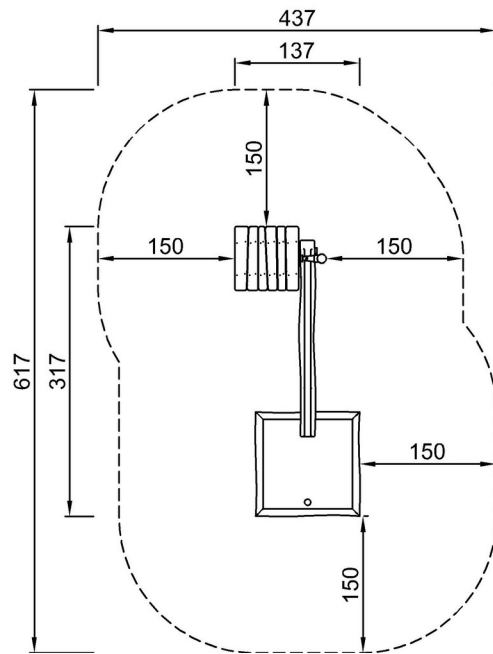

NRO508-xx01
*19cm
**107cm
***22.9m²

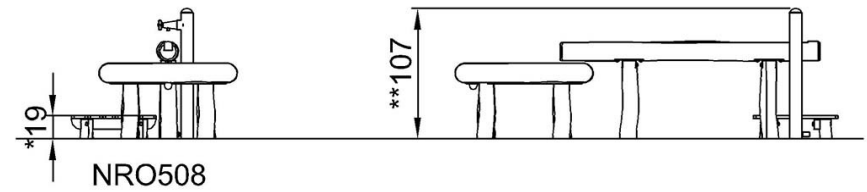

[Click to see TOP VIEW](#)

[Click to see SIDE VIEW](#)