

Creative Workshop

MSC5408

KOMPANI
Let's play

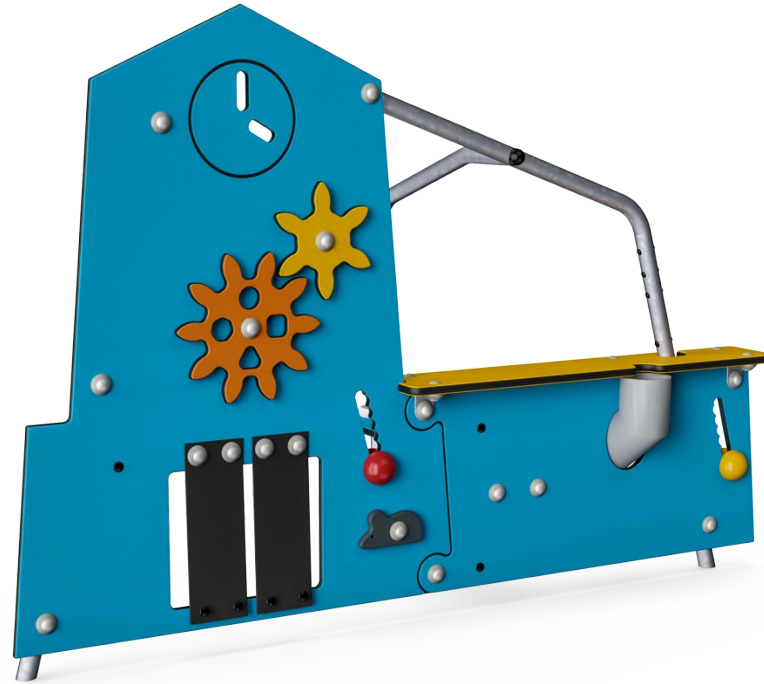

Item no. MSC540800-3417P

General Product Information

Dimensions LxWxH	175x82x124 cm
Age group	6m+
Play capacity (users)	4
Color options	

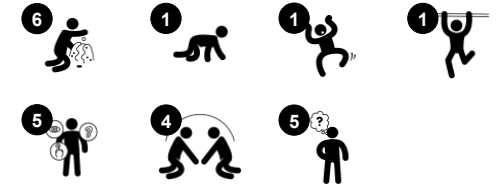

Wow! The fantastic creative workshop immediately attracts toddlers and their parents to play in so many creative ways, leading to longer playtimes and enhanced development due to the clever features. Children play longer when they can manipulate objects and discover the cause and effect actions of their bodies upon the materials. The Creative Workshop is

loaded with opportunities for play. The moving spheres, gears, and tiny mouse all offer different types of cause and effect movements. This will support motor planning. The play space has a desk and an exciting tube that will provide hours of cognitive excitement for a young child when working out how objects can move from one side of the structure to the

other. This also can become an imaginative social game with peers. So much fun in a small space!



Data is subject to change without prior notice.

Creative Workshop

MSC5408

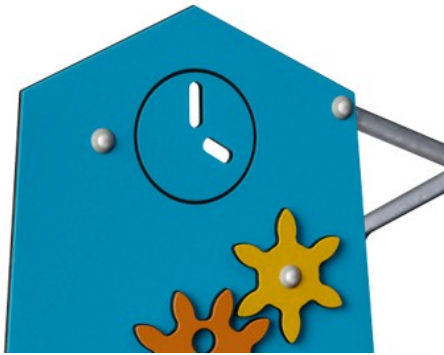

Panels of 19mm EcoCore™. EcoCore™ is a highly durable, eco friendly material, which is not only recyclable after use, but also consists of material produced from +95% recycled post consumer material from food packing waste.



The steel surfaces are hot dip galvanised inside and outside with lead free zinc. The galvanisation has excellent corrosion resistance in outside environments and requires low maintenance.



Straps are made of soft and bendable woven bands. Base material is PP which has good wearing and impact resistance.

Item no. MSC540800-3417P

Installation Information

Max. fall height	0 cm
Safety surfacing area	14.0 m ²
Total installation time	4.9
Excavation volume	0.13 m ³
Concrete volume	0.00 m ³
Footing depth (standard)	60 cm
Shipment weight	47 kg
Anchoring options	In-ground ✓ Surface ✓

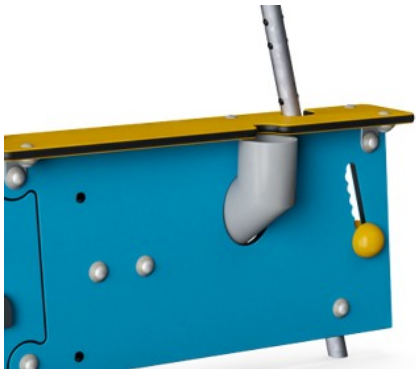

Sand pipe is made of PP. PP has good wearing and impact resistance.



Play spheres are made of PP. PP has good wearing and impact resistance.



Sand strainer is made of high-quality stainless steel to ensure durability of the product.



Sustainability Data

MSC5408

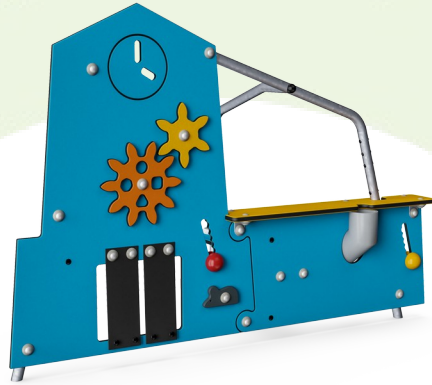

Cradle to Gate A1-A3	Total CO ₂ emission	CO ₂ e/kg	Recycled materials
	kg CO ₂ e	kg CO ₂ e/kg	%
MSC540800-3417P	80.50	1.81	72.20

The overall framework applied for these factors is the Environmental Product Declaration (EPD), which quantifies "environmental information on the life cycle of a product and enable comparisons between products fulfilling the same function" (ISO, 2006). This follows the structure and applies a Life-Cycle Assessment approach to the entire Product stage from raw material through manufacturing (A1-A3))

Kompan A/S
C.F. Tietgens Boulevard 32C
DK-5220 Odense SØ
Denmark



Verification of CO₂ calculation of: Themed play systems



Data version no. 2023-10-05

The CO₂ calculation and data are in compliance with the principles of a carbon footprint impact according to the GHG protocol (Greenhouse Gas Protocol), Scope 3, cradle to gate related to all individual components in the product category: "Themed play systems" represented by item no.: MSC641100-3717P.

(Scope 3 emissions include emission sources in the upstream and downstream value chain).

Date: 30. October 2023 | Valid until: 30. October 2025

Verified by:

Julie Marie Vejsgaard Larsen, LCA & EPD Consultant

Verification based on report: Validation of CO₂ calculation of 9 categories of Kompan product line, version 1.0, prepared by: Bureau Veritas HSE, Denmark: Julie M. V. Larsen.

Publication date: 30. October 2023

By Bureau Veritas HSE
www.bureauveritas.dk
+45 7731 1000



Creative Workshop

MSC5408

* Max fall height | ** Total height | *** Safety surfacing area

* Max fall height | ** Total height

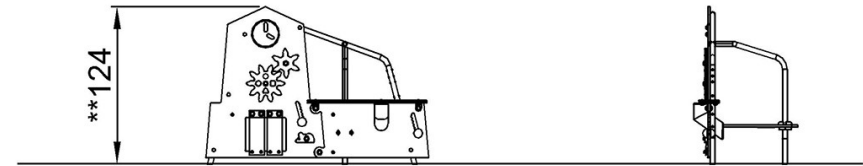
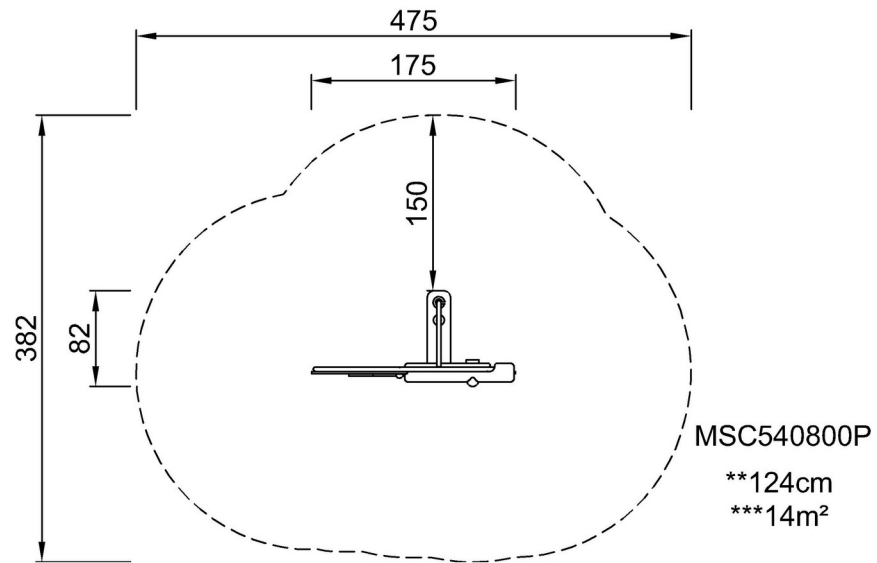

MSC540800P

[Click to see TOP VIEW](#)

[Click to see SIDE VIEW](#)