

Horse Seesaw

M182

Item no. M18213-01P

General Product Information

Dimensions LxWxH	35x310x95 cm
Age group	3+
Play capacity (users)	2
Color options	

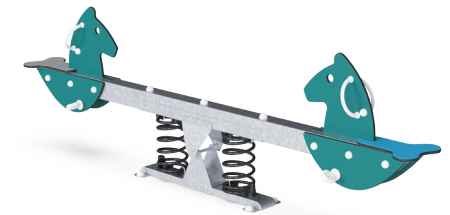
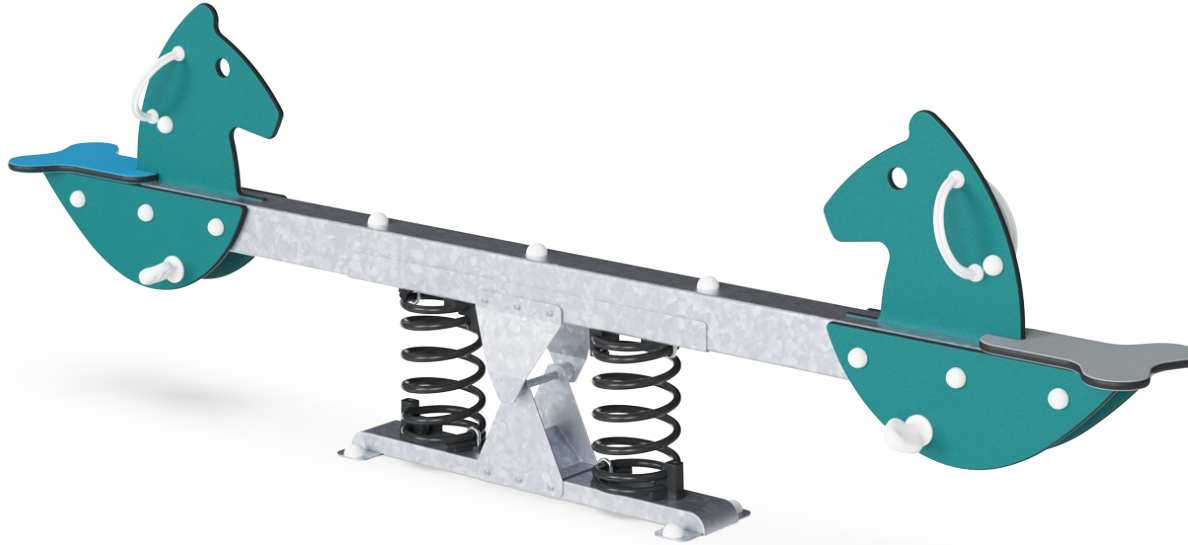

The Horse seesaw with its friendly-looking horses and vibrant colors invite children to try out the rocking experience. Due to the supportive ergonomics, children will play intensely for a long time and come back time and time again. The springs make it possible for users of different ages and sizes to rock together. Adults can participate, too. The

rounded seats and foot and hand holds allow children to give it a good go, even if they are nervous at first. The handgrips support a firm hold for a range of hand sizes. Rocking on the Horse seesaw is a different seesaw experiences, as the springs allows for users of different numbers, weights and abilities to play and cooperate. The seesaw is great for

cooperative play: the child needs to consider the rhythm of the other players' movements. This is good training for cooperation and consideration and allows children with conditions such as autism to get a chance for social play in a secure framework.

Horse Seesaw

M182



Theme

Cognitive: suggests a theme and supports dramatic play, which stimulates language and communication skills.

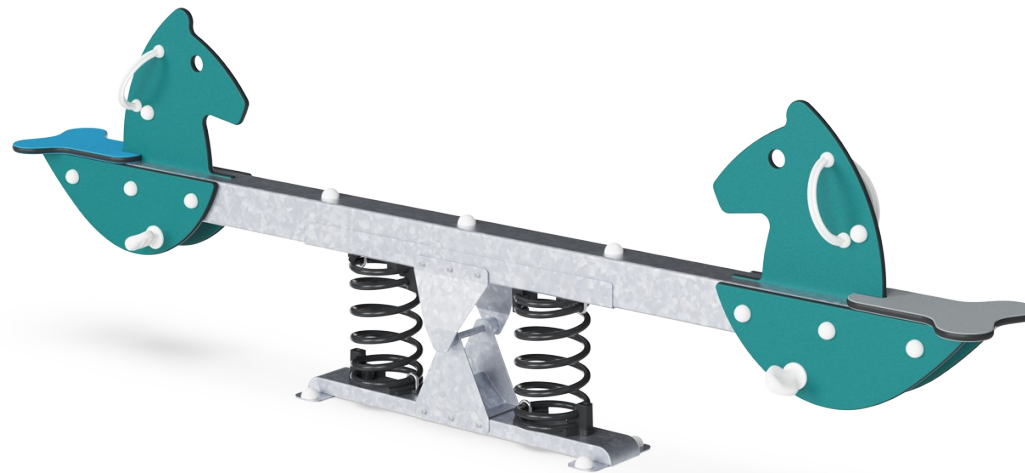

Rocking together

Social-Emotional: the possibility of rocking two together trains cooperation skills. Consideration of others when rocking.



Foot support

Physical: a good footrest supports intensive rocking. Rocking stimulates the senses of balance and space that are fundamental in managing the world securely. To rock intensely also supports coordination and muscle strength.



Rocking spring

Physical: response to movements adds to spatial awareness and sense of balance. These are fundamental motor skills that help the child's ability to sit still on a chair which takes a good sense of balance. **Cognitive:** trains the understanding of cause and effect: when I move my body, the spring responds with movement.



Handhold

Physical: the vertical handgrips ensure a firm grip at different heights, necessary for rocking intensely. This trains hand and arm muscles.

Horse Seesaw

M182



Panels of 19mm EcoCore™. EcoCore™ is a highly durable, eco friendly material, which is not only recyclable after use, but also consists of material produced from +95% recycled post consumer material from food packing waste.



KOMPAN Springs are made of high quality spring steel according to EN10270. The springs are cleaned by phosphating before they are painted with an epoxy primer and a polyester powder coating as top finish. The springs are fixed by unique anti pinch fittings for maximum safety and long lifetime.



The springs are fixed by unique anti pinch fittings for maximum safety and long lifetime.

Item no. M18213-01P	
Installation Information	
Max. fall height	100 cm
Safety surfacing area	10.6 m ²
Total installation time	4.3
Excavation volume	0.43 m ³
Concrete volume	0.00 m ³
Footing depth (standard)	42 cm
Shipment weight	160 kg
Anchoring options	In-ground ✓ Surface ✓



Handholds and footrests are made of injection moulded high quality nylon (PA6). PA6 has good wearing and impact strength.



The steel support posts are hot dip galvanised inside and outside with lead free zinc. The galvanisation has excellent corrosion resistance in outside environments and requires low maintenance.

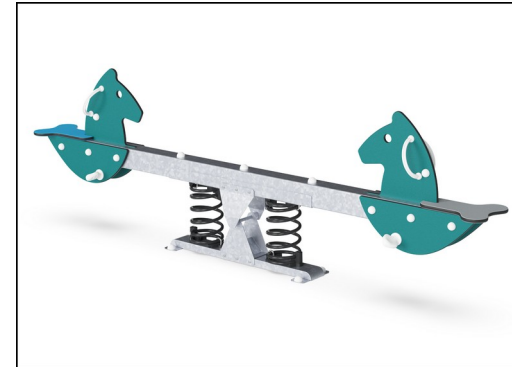

KOMPAN GreenLine versions are designed with ultimate environmentally friendly materials with lowest possible CO2e emission factor such as EcoCore™ panels of +95% post consumer recycled ocean waste.



Sustainability Data

M182

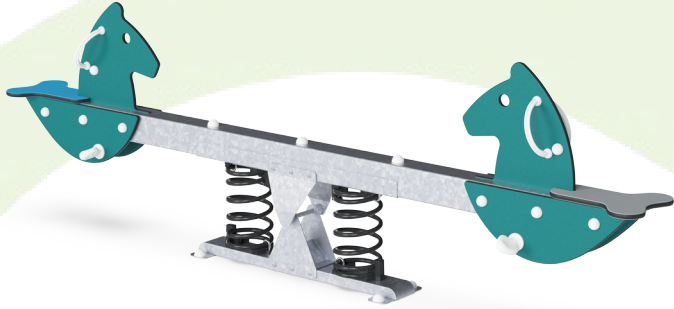

Cradle to Gate A1-A3	Total CO ₂ emission	CO ₂ e/kg	Recycled materials
	kg CO ₂ e	kg CO ₂ e/kg	%
M18213-01P	255.06	2.41	50.62

The overall framework applied for these factors is the Environmental Product Declaration (EPD), which quantifies "environmental information on the life cycle of a product and enable comparisons between products fulfilling the same function" (ISO, 2006). This follows the structure and applies a Life-Cycle Assessment approach to the entire Product stage from raw material through manufacturing (A1-A3))

Kompan A/S
 C.F. Tietgens Boulevard 32C
 DK-5220 Odense SØ
 Denmark



Verification of CO₂ calculation of: Freestanding play equipment



Data version no. 2023-10-05

The CO₂ calculation and data are in compliance with the principles of a carbon footprint impact according to the GHG protocol (Greenhouse Gas Protocol), Scope 3, cradle to gate related to all individual components in the product category: "Freestanding play equipment" represented by item no.: GXY916012-3417.

(Scope 3 emissions include emission sources in the upstream and downstream value chain).

Date: 30. October 2023 | Valid until: 30. October 2025

Verified by:

Julie Marie Vejsgaard Larsen, LCA & EPD Consultant

Verification based on report: Validation of CO₂ calculation of 9 categories of Kompan product line, version 1.0, prepared by: Bureau Veritas HSE, Denmark: Julie M. V. Larsen.

Publication date: 30. October 2023

By Bureau Veritas HSE
 www.bureauveritas.dk
 +45 7731 1000



Horse Seesaw

M182

* Max fall height | ** Total height | *** Safety surfacing area

* Max fall height | ** Total height

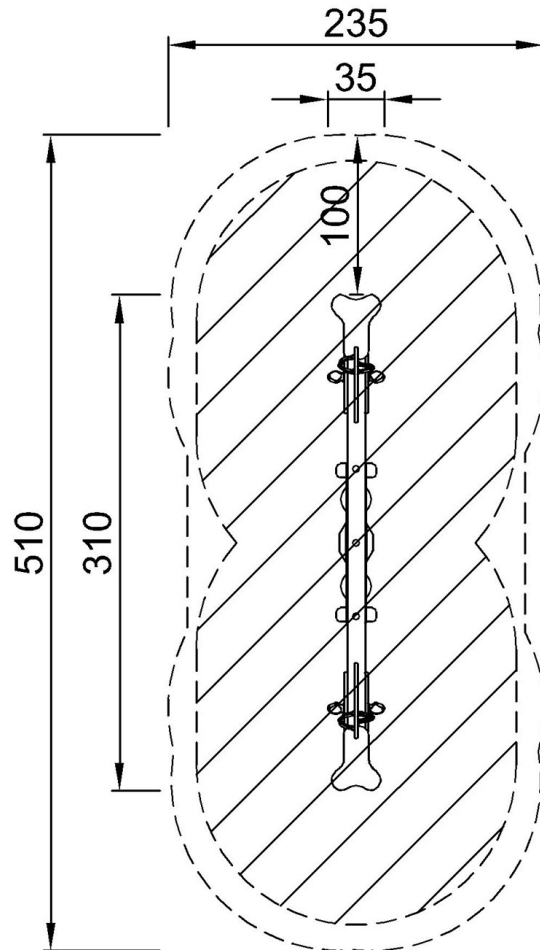

M18213
*100cm
**95cm
***10.6m²

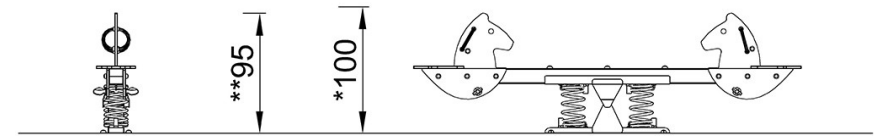

M18213

[Click to see TOP VIEW](#)

[Click to see SIDE VIEW](#)