

Little Mermaid & Ugly Duckling

MSC6430

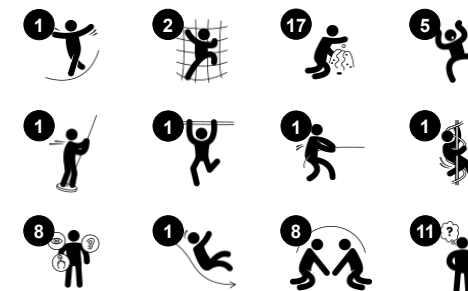

Item no. MSC643000-3717P	
General Product Information	
Dimensions LxWxH	16'11"x13'9"x12'1"
Age group	2 - 5
Play capacity (users)	24
Color options	●



The highly appealing fairytale themes of The Ugly Duckling and the Little Mermaid have a huge attraction on all children and adults. The QR-codes give free access to a whole fairytale world with e-books and educational games in 16 languages. The awesome variety of play events for the mind and body attract children to play and explore, again and again. The

fairytale manipulatives inspire dramatic play, which is a great training of language skills. These play features also train logical thinking skills when children figure out their function. All these elements can be worked from both sides of the panels, spurring social interaction and adding play capacity. The wide variety of climbing, sliding, jumping activities train basic

motor skills important for navigating the world securely. The accessible stairway provides easy access: play for all!

Little Mermaid & Ugly Duckling

MSC6430



Megaphone

Social-Emotional: inspires communication and turn-taking skills. **Cognitive:** distortion of sound evokes curiosity and stimulates an understanding of cause and effect.



Slide

Physical: sliding develops spatial awareness and a sense of balance. Furthermore, the core muscles are trained when sitting upright going down. **Social-Emotional:** empathy stimulated by turn-taking. **Cognitive:** young children develop their understanding of space, speed and distances when sliding down quickly.

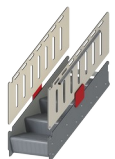

Accessible stairway

Physical: climbing the accessible stairway is for all and supports cross coordination as well as arm and leg muscles. For young children, walking stairs and alternating feet is developed. **Social-Emotional:** room for active breaks and adult helpers. An inclusive space.

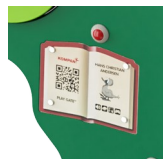

Book with QR-code

Cognitive: scan the code and access a range of e-books and educational games in your native or 15 other languages. Scanning in a range of e-books with fairytales or playful learning games, centered around languages and story-telling. **Creative:** scanning in an AR (Augmented Reality) element that allows for creating photos in real time with figures from the Hans Christian Andersen fairytales.

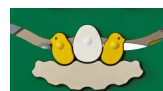

Nest with eggs

Social-Emotional: eggs can be run from both sides of the panel, supporting cooperation and turn-taking skills. **Cognitive:** cause and effect understanding and language skills are trained when describing the movement of the eggs. **Creative:** placing the eggs in different patterns and positions, leaving a mark.



Curly climber

Physical: coordination and proprioception are supported when placing arms and legs correctly for going down. Sense of balance when rotating. Arm muscles for holding tight. **Social-Emotional:** empathy stimulated by turn-taking. **Cognitive:** logical thinking when placing arms and legs right for rotating downward.



Binoculars

Cognitive: the binoculars set a tangible theme and so spur dramatic play. Dramatic play is great for developing language and communication skills. **Creative:** the binoculars can be turned in all directions. Looking through them gives a new perspective on the world.

Little Mermaid & Ugly Duckling

MSC6430



Panels of 19mm EcoCore™. EcoCore™ is a highly durable, eco friendly material, which is not only recyclable after use, but also consists of a core produced from 100% recycled material.



All floors are made of High-Pressure Laminate HPL with a thickness 17.8mm and non skid surface texture according to EN 438-6. KOMPAN HPL has high wearing strength to ensure long lifetime in all climates.



Curved climbing wall is made of Ekogrip® panel that consist of a 15mm thick PE base with 3 mm top-layer of soft rubber with a non-skid effect.

Item no. MSC643000-3717P	
Installation Information	
Max. fall height	7'5"
Safety surfacing area	515ft ²
Total installation time	33.7
Excavation volume	1.19yd ³
Concrete volume	0yd ³
Footing depth (standard)	2'11"
Shipment weight	1998lbs
Anchoring options	In-ground ✓ Surface ✓
Warranty Information	
EcoCore HDPE	Lifetime
Hot dip galvanized steel	Lifetime
HPL decks	15 Years
Ropes & nets	10 Years
Spare Parts Availability	10 Years



The slides can be chosen in different materials: Straight molded PE slides or combined EcoCore™ sides and stainless steel slide bed t=2mm.



Climbing nets are made of UV-stabilized PP rope with inner steel cable reinforcement. The rope is induction treated to obtain maximum fixation between steel and rope which provides excellent wear and tear resistance. All rope connectors are made of 100% recyclable PA material.

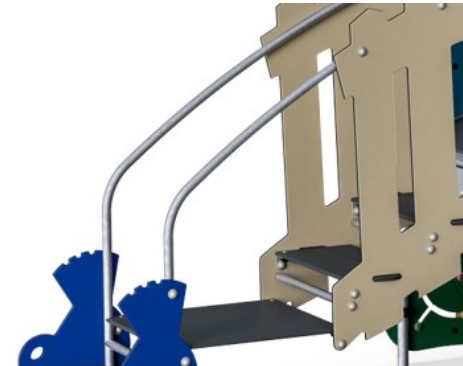

The steel surfaces are hot-dip galvanized inside and outside with lead-free zinc. The galvanization has excellent corrosion resistance in outside environments and requires minimal maintenance.

Elevated activities 6	Accessible elevated activities	Accessible ground level activities	Accessible ground level play types
Present	6	6	3
Required	3	2	2

ASTM F1487
compliant

Sustainability Data

MSC6430



Cradle to Gate A1-A3	Total CO ₂ emission	CO ₂ e/kg	Recycled materials
	kg CO ₂ e	kg CO ₂ e/kg	%
MSC643000-3717P	1,550.89	1.97	60.33

The overall framework applied for these factors is the Environmental Product Declaration (EPD), which quantifies "environmental information on the life cycle of a product and enable comparisons between products fulfilling the same function" (ISO, 2006). This follows the structure and applies a Life-Cycle Assessment approach to the entire Product stage from raw material through manufacturing (A1-A3))

Kompan A/S
 C.F. Tietgens Boulevard 32C
 DK-5220 Odense SØ
 Denmark



Verification of CO₂ calculation of: Themed play systems



Data version no. 2023-10-05

The CO₂ calculation and data are in compliance with the principles of a carbon footprint impact according to the GHG protocol (Greenhouse Gas Protocol), Scope 3, cradle to gate related to all individual components in the product category: "Themed play systems" represented by item no.: MSC641100-3717P.

(Scope 3 emissions include emission sources in the upstream and downstream value chain).

Date: 30. October 2023 | Valid until: 30. October 2025

Verified by:

Julie Marie Vejsgaard Larsen, LCA & EPD Consultant

Verification based on report: Validation of CO₂ calculation of 9 categories of Kompan product line, version 1.0, prepared by: Bureau Veritas HSE, Denmark: Julie M. V. Larsen.

Publication date: 30. October 2023

By Bureau Veritas HSE
 www.bureauveritas.dk
 +45 7731 1000



Little Mermaid & Ugly Duckling

MSC6430

* Max fall height | ** Total height | *** Safety surfacing area

* Max fall height | ** Total height

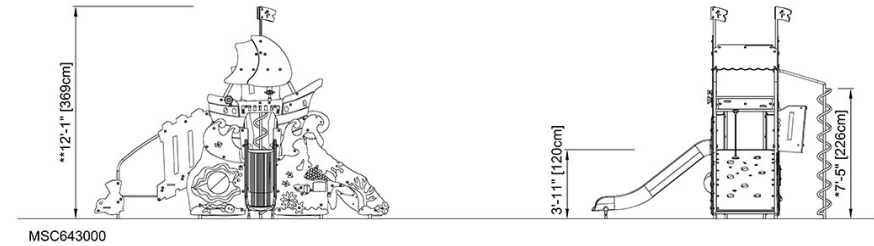
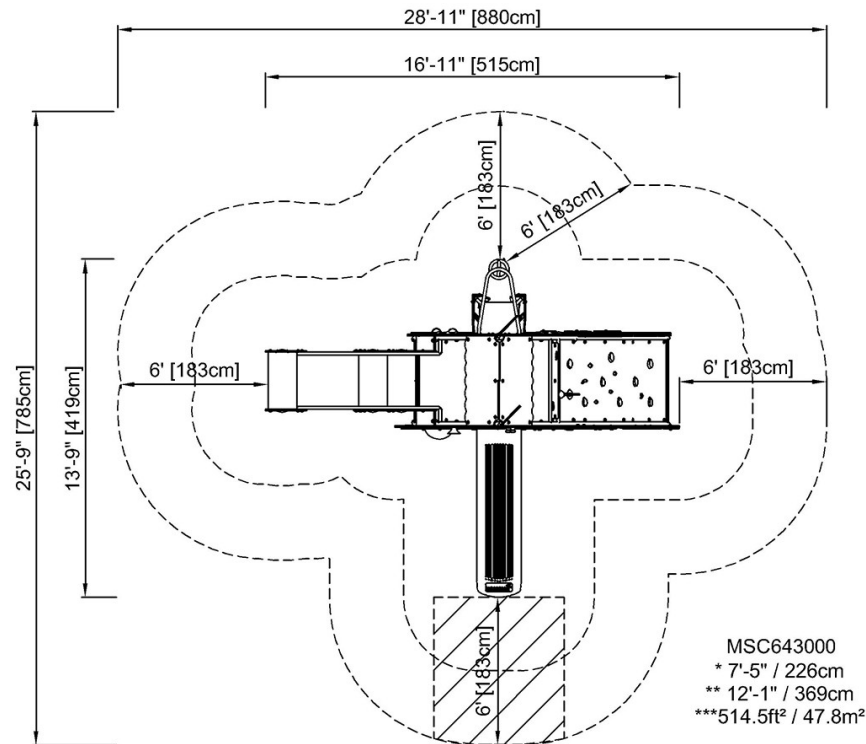

[Click to see TOP VIEW](#)

[Click to see SIDE VIEW](#)