

# Rider

PCE50121

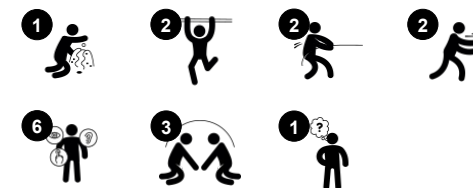

Item no. PCE50121-0603	
<b>General Product Information</b>	
Dimensions LxWxH	120x179x237 cm
Age group	2+
Play capacity (users)	9
Colour options	



The whimsical look of the Rider attracts children's curiosity. Irresistible, they just have to try it out! Due to the fine sensory and gross motor activities of the Rider, retention is ensured: the density of play activities in a cosy space is obvious. By the children or adults pushing or pulling, the Rider can be turned to face different ways. This trains major muscles

and the spatial awareness. It also provides variety in play. The seat in the middle also functions as a table, and the steering wheel turns it into a vehicle, stimulating the children's imagination. The huge rounded window not only provides a great lookout to the outside, it also distorts the sound of the voice, a great attraction and cause and effect function,

developing the children's logical thinking.



# Rider

PCE50121



## Bubble Window

**Social-Emotional:** invites interaction between outside and inside. **Cognitive:** distorts the sound of the voice, developing logical thinking.



## Turning wheel

**Cognitive:** the manipulative item stimulates cause and effect understanding.



## Bench

**Social-Emotional:** gathering, cooperating or taking a break from play - all train social skills.

# Rider

PCE50121



The Curved ELEMENTS panels are moulded of UV stabilised recyclable PE using 33% post-consumer recycled material. With multiple options for in-build play features that also ensures a strong panel solution. Straight panels are made of KOMPAN 19mm HDPE EcoCore™ which is a highly durable, ecofriendly and recyclable material made from +95% PCM.

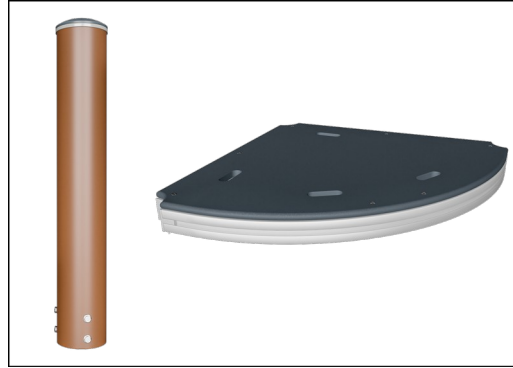

ELEMENTS decks are made of 17.8mm thick HPL supported by a unique designed aluminum frame with multiple attachment options by usage of aluminum connectors. The main posts are made of high quality pre-galvanised steel with powder coated top finish. Post tops are closed with caps of UV stabilised nylon (PA6).



ELEMENTS products are available in three different colour combinations: classic blue & green, blossom orange & yellow, nature lime and green.

Item no. PCE50121-0603

### Installation Information

Max. fall height	30 cm
Safety surfacing area	18.1 m <sup>2</sup>
Total installation time	6.6
Excavation volume	0.06 m <sup>3</sup>
Concrete volume	0.00 m <sup>3</sup>
Footing depth (standard)	60 cm
Shipment weight	151 kg
Anchoring options	Surface ✓ In-ground ✓

### Warranty Information

Curved panels	10 years
EcoCore HDPE	Lifetime
HPL	15 years
Post	10 years
Spare parts guaranteed	10 years



# Sustainability Data

PCE50121



Cradle to Gate A1-A3	Total CO <sub>2</sub> emission	CO <sub>2</sub> e/kg	Recycled materials
	kg CO <sub>2</sub> e	kg CO <sub>2</sub> e/kg	%
<b>PCE50121-0603</b>	372.97	3.31	31.62

The overall framework applied for these factors is the Environmental Product Declaration (EPD), which quantifies "environmental information on the life cycle of a product and enable comparisons between products fulfilling the same function" (ISO, 2006). This follows the structure and applies a Life-Cycle Assessment approach to the entire Product stage from raw material through manufacturing (A1-A3))

**Kompan A/S**  
 C.F. Tietgens Boulevard 32C  
 DK-5220 Odense SØ  
 Denmark



## Verification of CO<sub>2</sub> calculation of: Play systems



Data version no. 2023-10-05

The CO<sub>2</sub> calculation and data are in compliance with the principles of a carbon footprint impact according to the GHG protocol (Greenhouse Gas Protocol), Scope 3, cradle to gate related to all individual components in the product category: "Play systems" represented by item no.: PCM200321-0950.

(Scope 3 emissions include emission sources in the upstream and downstream value chain).

**Date: 30. October 2023 | Valid until: 30. October 2025**

Verified by:

Julie Marie Vejsgaard Larsen, LCA & EPD Consultant

Verification based on report: Validation of CO<sub>2</sub> calculation of 9 categories of Kompan product line, version 1.0, prepared by: Bureau Veritas HSE, Denmark: Julie M. V. Larsen.

**Publication date: 30. October 2023**

By Bureau Veritas HSE  
 www.bureauveritas.dk  
 +45 7731 1000



# Rider

PCE50121

\* Max fall height | \*\* Total height | \*\*\* Safety surfacing area

\* Max fall height | \*\* Total height

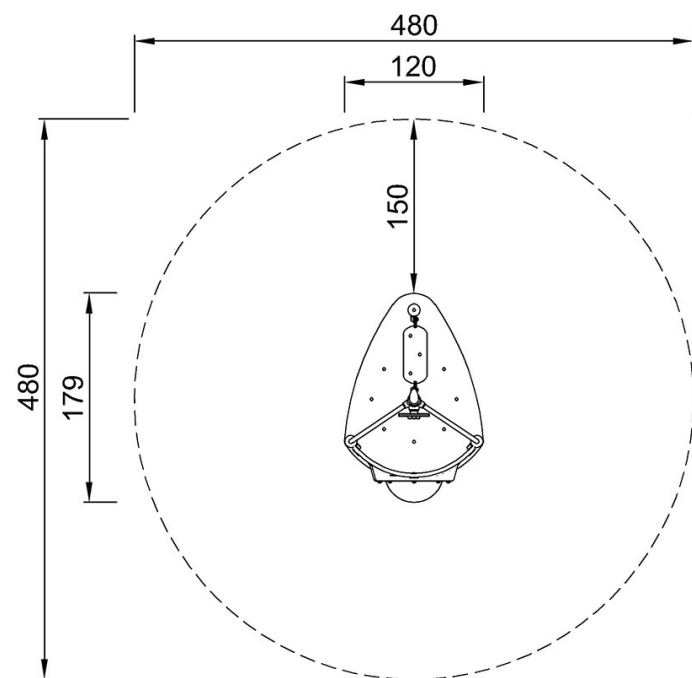

PCE50121  
\*30cm  
\*\*237cm  
\*\*\*18.1m<sup>2</sup>

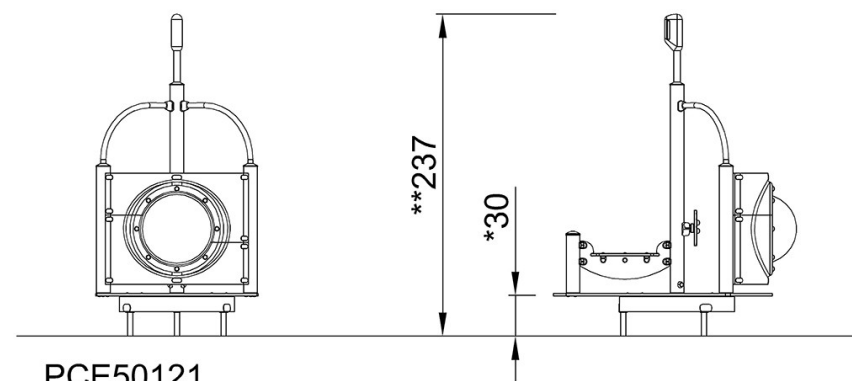

PCE50121

[Click to see TOP VIEW](#)

[Click to see SIDE VIEW](#)