

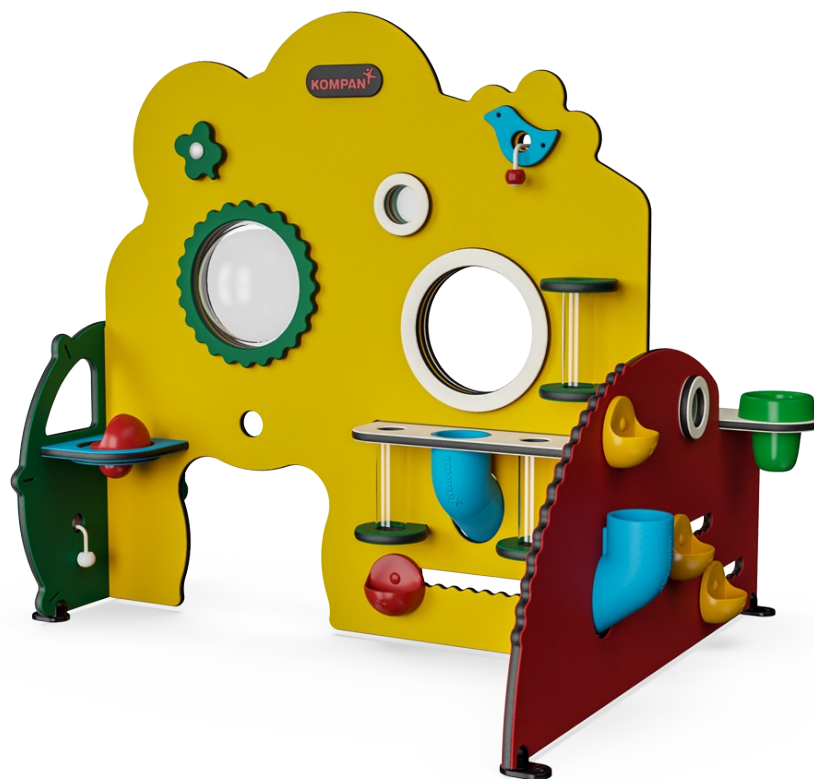

Green House & Florist

MSV604



Item no. MSV60400-0201	
General Product Information	
Dimensions LxWxH	146x120x121 cm
Age group	6m - 4
Play capacity (users)	8
Colour options	

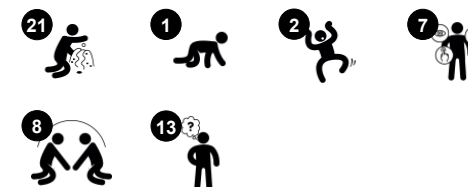

Wow! Children are immensely attracted to the activity of the Green House & Florist. In a small space, children play intensely, again and again. Loaded with play, the play unit benefits the children's physical, social-emotional, cognitive and creative development. Numerous play features encourage social play as they unite children with tangible, cross-panel play

activities: the tube, sand scoop and string with knob. The Green House & Florist has tangible themes: switch, bell, scoops making sounds when run in the toothed grooves, see-through flower vases. These scaffold logical thinking skills as children push, pull and investigate the numerous play items stimulate the child's logical thinking skills. The rich themes in-spire

dramatic play, which is phenomenal for language development: a main factor for learning, friendships and life success.



Green House & Florist

MSV604



Funnel

Social-Emotional: trains cooperation and turn-taking as children put materials into the funnel. **Cognitive:** the passing of materials through funnels supports the children's logical thinking and for younger children the understanding of object permanence: that materials don't vanish but run through at the other end.

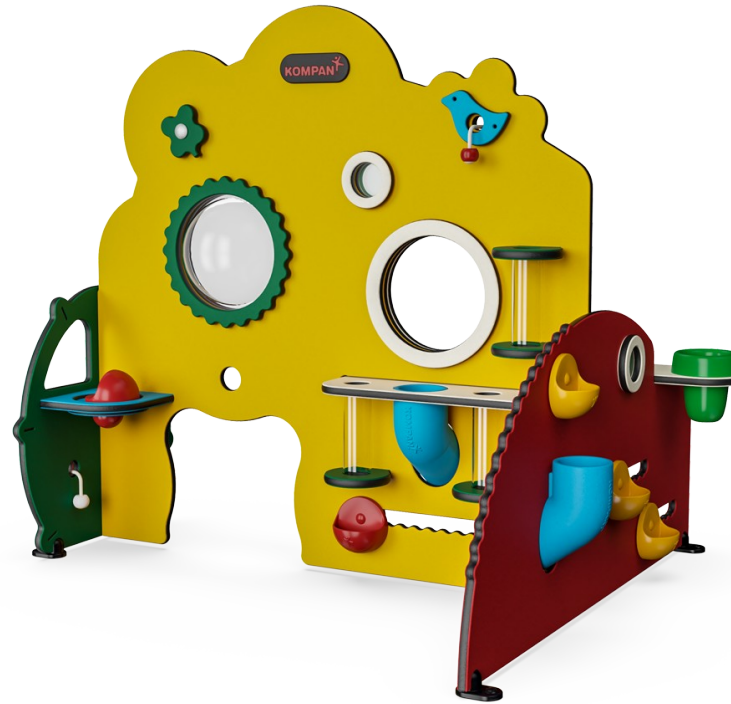

See-through tubes

Social-Emotional: the paired tubes invite parallel and cooperative play. **Cognitive:** construction play and the understanding of object permanence are supported when shifting items through the see-through tubes.

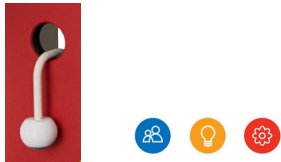

String with knobs

Social-Emotional: turn-taking and cooperation are supported when pulling the string from side to side with friends or caregiver. **Cognitive:** an understanding of object permanence is supported when the knob disappears and reappears when pulled. **Creative:** leaving the knob in different positions can support symbolic and creative thinking.



Bubble Window

Social-Emotional: invites interaction between outside and inside. **Cognitive:** distorts the sound of the voice, developing logical thinking.

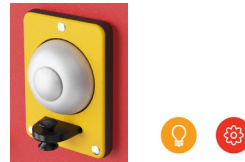

Bell

Cognitive: understanding cause and effect when ringing bell. **Creative:** leaving a mark in creating a sound rhythm when ringing or knocking the bell.



Pot

Cognitive: the pot can be removed, stimulating cause and effect understanding. Filling and emptying the pot stimulates logical thinking and the understanding of concepts such as empty and full. **Creative:** placing the pot in other areas of the play space in creative ways can support symbolic and creative thinking.



Sand scoops

Physical: hand eye coordination and push-pull movements. **Social-Emotional:** invites cooperation due to the two-sidedness and provides for parallel play. **Cognitive:** logical thinking: cause and effect understanding when running scoops in grooves or shifting materials from scoop to scoop. **Creative:** shifting scoops, creating new scoop positions.

Green House & Florist

MSV604



Panels of 19mm EcoCore™. EcoCore™ is a highly durable, eco friendly material, which is not only recyclable after use, but also consists of material produced from +95% recycled post consumer material from food packing waste.

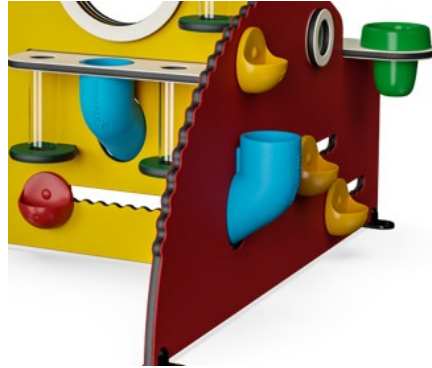

Sand Pipe is made with 33% post-consumer materials in different colors in one-piece design with a wall thickness of minimum 5mm. Material in accordance with the European Standard EN 71-3 and tested for UV stability.



Pots are made of pressure moulded high quality nylon (PA6). PA6 has good wearing and impact strength.

Item no. MSV60400-0201

Installation Information

Max. fall height	0 cm
Safety surfacing area	0.0 m ²
Total installation time	5.1
Excavation volume	0.00 m ³
Concrete volume	0.00 m ³
Footing depth (standard)	0 cm
Shipment weight	52 kg
Anchoring options	Surface ✓

Warranty Information

EcoCore HDPE	Lifetime
Membrane	2 years
Movable parts	2 years
PUR components	10 years
Spare parts guaranteed	10 years



On the side of the wall there is a transparent bubble made from UV-stabilised PC.



See-through tubes are made of PPMA. PPMA has outstanding durability and resistance to UV radiation.

Elevated activities 0	Accessible elevated activities	Accessible ground level activities	Accessible ground level play types
Present	0	1	1
Required	0	1	1



Sustainability Data

MSV604

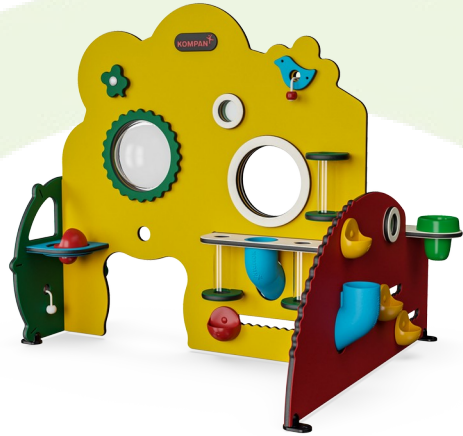

Cradle to Gate A1-A3	Total CO ₂ emission	CO ₂ e/kg	Recycled materials
	kg CO ₂ e	kg CO ₂ e/kg	%
MSV60400-0201	64.08	1.30	85.07

The overall framework applied for these factors is the Environmental Product Declaration (EPD), which quantifies "environmental information on the life cycle of a product and enable comparisons between products fulfilling the same function" (ISO, 2006). This follows the structure and applies a Life-Cycle Assessment approach to the entire Product stage from raw material through manufacturing (A1-A3))

Kompan A/S
C.F. Tietgens Boulevard 32C
DK-5220 Odense SØ
Denmark



Verification of CO₂ calculation of: Themed play systems



Data version no. 2023-10-05

The CO₂ calculation and data are in compliance with the principles of a carbon footprint impact according to the GHG protocol (Greenhouse Gas Protocol), Scope 3, cradle to gate related to all individual components in the product category: "Themed play systems" represented by item no.: MSC641100-3717P.

(Scope 3 emissions include emission sources in the upstream and downstream value chain).

Date: 30. October 2023 | Valid until: 30. October 2025

Verified by:

Julie Marie Vejsgaard Larsen, LCA & EPD Consultant

Verification based on report: Validation of CO₂ calculation of 9 categories of Kompan product line, version 1.0, prepared by: Bureau Veritas HSE, Denmark: Julie M. V. Larsen.

Publication date: 30. October 2023

By Bureau Veritas HSE
www.bureauveritas.dk
+45 7731 1000



Green House & Florist

MSV604

* Max fall height | ** Total height | *** Safety surfacing area

* Max fall height | ** Total height

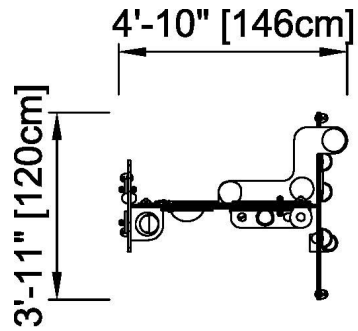

MSV60400

MSV60400-0201

** 4'-X" / 121cm
1/8" = 1'-0"

[Click to see TOP VIEW](#)

[Click to see SIDE VIEW](#)