



Stack & Turn Play Panel

NRC60101



Item no. NRC60101-1021	
General Product Information	
Dimensions LxWxH	125x21x101 cm
Age group	1+
Play capacity (users)	2
Colour options	 



The intriguing Stack and Turn play panel inspires small group and individual play again and again. The two vertical ropes feature each three flat rubber 'stones' that can be turned and stacked, training fine motor skills and coordination in pre-schoolers. The children spend time figuring out the functionality, how to turn the stone to lift it up, and how to turn it to

make it stay in its stack. They also figure out how to sequence actions to manage stacking. This takes logical thinking skills and builds up the fundament for strategic thinking.



Stack & Turn Play Panel

NRC60101



Stack and Turn Panel

Physical: Shifting the rubber spheres up and down the rope, across the 'lock' trains hand-eye coordination, important for motor control.

Social-Emotional: Shifting the spheres and stacking them in cooperation supports negotiation and turn-taking.

Cognitive: figuring out how to turn the rubber spheres to pass the 'lock' stimulates logical thinking skills and understanding of sequence. **Creative:** placing the ovals in new positions leaves a mark.



Stack & Turn Play Panel

NRC60101



Ropes of UV-stabilized PES rope strands with inner steel cable reinforcement. The polyester yarn is made of +95% Post-consumer materials and is inductively melted onto each strand to obtain excellent wear and tear resistance.



Corocord membranes consist of friction-proof rubberized material of conveyor belt quality with excellent UV resistance. Tested and compliant with REACH requirements for PAH. Embedded is a four-layered armouring made of woven polyester. The armouring and the two surface layers result in a total thickness of 8 mm.

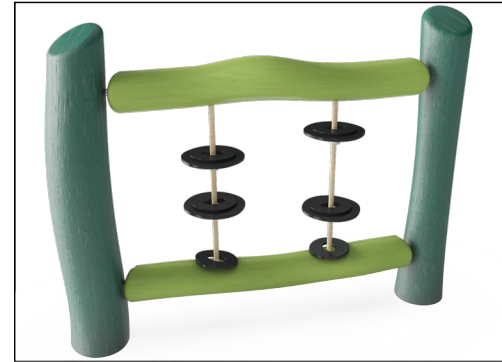

All Organic Robinia products by KOMPAN are made of Robinia wood from sustainable European sources. On request it can be supplied as FSC® Certified (FSC® C004450).

Item no. NRC60101-1021

Installation Information

Max. fall height	0 cm
Safety surfacing area	15.5 m ²
Total installation time	3.0
Excavation volume	0.50 m ³
Concrete volume	0.36 m ³
Footing depth (standard)	100 cm
Shipment weight	116 kg
Anchoring options	In-ground ✓

Warranty Information

Corocord rope	10 years
Membrane	2 years
Robinia wood	15 years
Spare parts guaranteed	10 years



Transparent brown pigmented and colored parts, are coated with water-based paint and pigment that is environmentally friendly and with excellent UV resistance. The paint and pigment is in compliance with EN 71 Part 3.



There are Multiple footing options for all products: Surface anchoring with steel footings and expansion bolts. Wood in-ground or steel in-ground footings.



Sustainability Data

NRC60101



Cradle to Gate A1-A3	Total CO ₂ emission	CO ₂ e/kg	Recycled materials
	kg CO ₂ e	kg CO ₂ e/kg	%
NRC60101-1021	25.70	0.26	1.07

The overall framework applied for these factors is the Environmental Product Declaration (EPD), which quantifies "environmental information on the life cycle of a product and enable comparisons between products fulfilling the same function" (ISO, 2006). This follows the structure and applies a Life-Cycle Assessment approach to the entire Product stage from raw material through manufacturing (A1-A3))

Kompan A/S
C.F. Tietgens Boulevard 32C
DK-5220 Odense SØ
Denmark



Verification of CO₂ calculation of: Nature play



Data version no. 2023-10-05

The CO₂ calculation and data are in compliance with the principles of a carbon footprint impact according to the GHG protocol (Greenhouse Gas Protocol), Scope 3, cradle to gate related to all individual components in the product category: "Nature play" represented by item no.: NRO409-0621.

(Scope 3 emissions include emission sources in the upstream and downstream value chain).

Date: 30. October 2023 | Valid until: 30. October 2025

Verified by:

Julie Marie Vejsgaard Larsen, LCA & EPD Consultant

Verification based on report: Validation of CO₂ calculation of 9 categories of Kompan product line, version 1.0, prepared by: Bureau Veritas HSE, Denmark: Julie M. V. Larsen.

Publication date: 30. October 2023

By Bureau Veritas HSE
www.bureauveritas.dk
+45 7731 1000



Stack & Turn Play Panel

NRC60101

* Max fall height | ** Total height | *** Safety surfacing area

* Max fall height | ** Total height

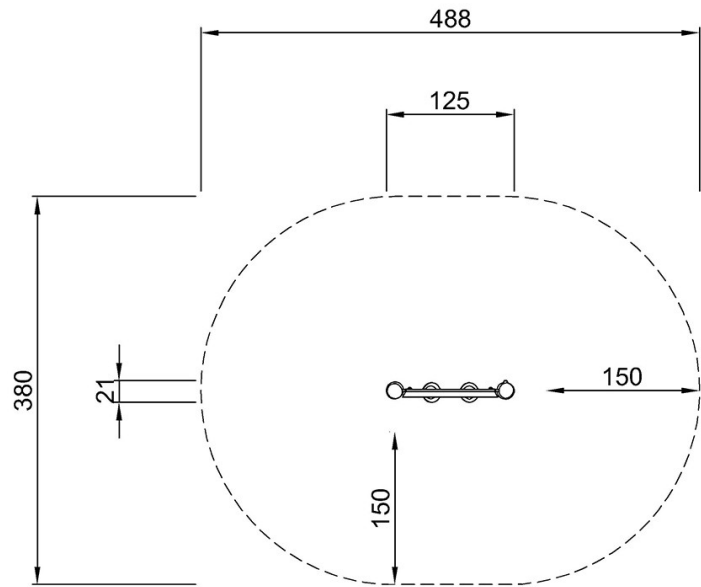

NRC60101
**101cm
***15.5m²

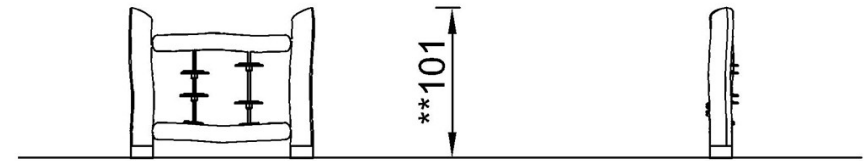

NRC60101

[Click to see TOP VIEW](#)

[Click to see SIDE VIEW](#)