

Niagara

NAT527



With its multiple thrilling climbs, the Niagara hugely attracts world explorers among school age children. The variety of challenging climbs and crawls via nets, poles, ladders and tilted floors will make children return for more play again and again. The varied ways up and down stimulate children's balance and cross-coordination, and the proprioception: The

inclined, straight, swaying and firm climbs provide fun challenges for dare devils as well as more cautious explorers. The motor skills trained are important for children's physical confidence and their security in moving, for instance in the street. The senses of balance and space are trained whizzing down the banister bars. These skills are fundamental for

all other physical skills. The platform and net are nice meeting points for socializing with friends, planning new climbs.

Item no. NAT527-0912

General Product Information

Dimensions LxWxH	452x644x312 cm
Age group	6+
Play capacity (users)	13
Color options	

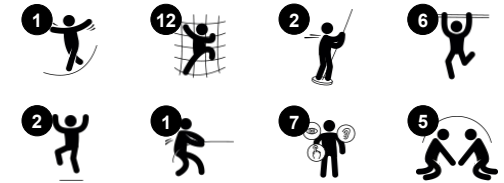

Niagara

NAT527



Overhead ladder

Physical: develops children's upper body muscles and arm strength, cross coordination and spatial awareness. This is especially important due to sedentary lifestyles and back-pain in children. **Social-Emotional:** chill and socialize on top of the overhead ladder, training cooperation.



Banister bars

Physical: coordination is supported when going down, as well as arm and core muscles. Landing strengthens bone density, which is built for life in childhood. **Social-Emotional:** turn-taking and risk-taking.



Fireman's pole

Physical: coordination is supported when going down, as well as arm and core muscles. Landing strengthens bone density, which is built for life in early childhood. **Social-Emotional:** turn-taking and risk-taking.



Climbing pole

Physical: develops children's cross coordination, eye-hand coordination and muscle strength when climbing up or down. **Social-Emotional:** turn-taking and self-regulation are trained, both important life skills.



Inclined platform

Physical: trains the sense of balance and space. **Social-Emotional:** courage, self-confidence, consideration and turn-taking, all important life skills, get practiced.



Climbing net

Physical: children develop cross-body coordination and muscle strength. The asymmetry of the net challenges the children's climbing and crawling through. **Social-Emotional:** the big meshes allow for more children seated together, sharing.

Niagara

NAT527

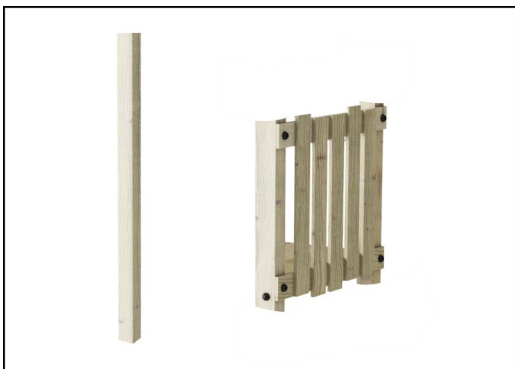

Posts and boards are made of pine wood from sustainable European sources. The wood is pressure impregnated Class 3 with Tanalith E3475 according to EN335 (Equivalent to NTR Class AB). On request it can be supplied as FSC® Certified (FSC® C004450).



Panels of 19mm EcoCore™. EcoCore™ is a highly durable, eco friendly material, which is not only recyclable after use, but also consists of material produced from +95% recycled post consumer material from food packing waste.

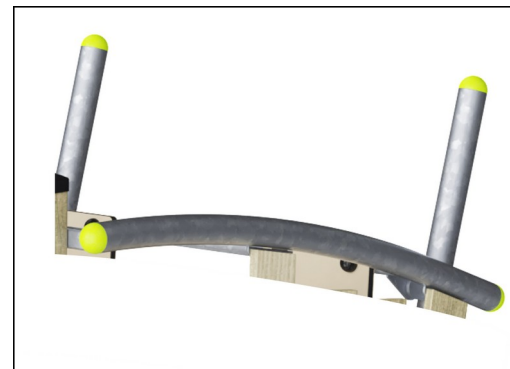

The steel surfaces are hot dip galvanized inside and outside with lead free zinc. The galvanization has excellent corrosion resistance in outside environments and requires low maintenance.



Corocord ropes of UV-stabilized PES rope strands with inner steel cable reinforcement. The polyester yarn is made from +95% post-consumer materials and is inductively melted onto each strand. PES has high strength with excellent resistance to abrasion and UV radiation. The rope loops are assembled by aluminum connectors.

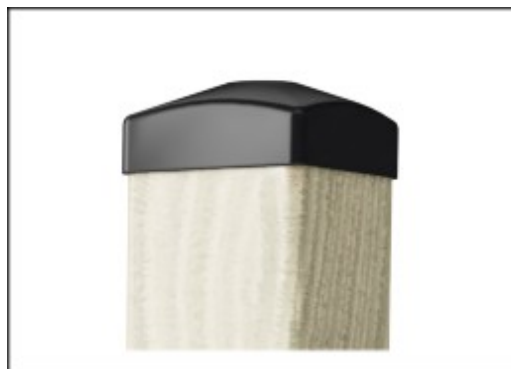

The post end caps are made of injection molded high quality nylon (PA6). PA6 has good wearing and impact strength and is UV stabilized. The end caps protects vertical placed posts to ensure long lifetime.

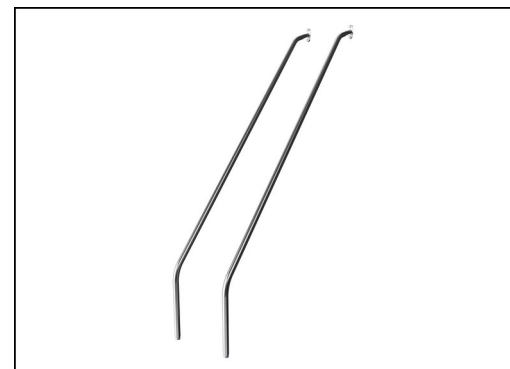

The stainless steel activities are made of high quality stainless steel. The steel is glass blasted after manufacturing to ensure a smooth gliding surface.

Item no. NAT527-0912

Installation Information

Max. fall height	267 cm
Safety surfacing area	49.4 m ²
Total installation time	14.1
Excavation volume	2.11 m ³
Concrete volume	0.41 m ³
Footing depth (standard)	91 cm
Shipment weight	451 kg
Anchoring options	In-ground ✓ Surface ✓

Warranty Information

EcoCore HDPE	Lifetime
Hot dip galvanised steel	Lifetime
Pinewood	10 years
Ropes & nets	10 years
Spare parts guaranteed	10 years



Sustainability Data

NAT527



Cradle to Gate A1-A3	Total CO ₂ emission	CO ₂ e/kg	Recycled materials
	kg CO ₂ e	kg CO ₂ e/kg	%
NAT527-0912	862.67	2.22	38.58

The overall framework applied for these factors is the Environmental Product Declaration (EPD), which quantifies "environmental information on the life cycle of a product and enable comparisons between products fulfilling the same function" (ISO, 2006). This follows the structure and applies a Life-Cycle Assessment approach to the entire Product stage from raw material through manufacturing (A1-A3))

Kompan A/S
 C.F. Tietgens Boulevard 32C
 DK-5220 Odense SØ
 Denmark



Verification of CO₂ calculation of: Nature play



Data version no. 2023-10-05

The CO₂ calculation and data are in compliance with the principles of a carbon footprint impact according to the GHG protocol (Greenhouse Gas Protocol), Scope 3, cradle to gate related to all individual components in the product category: "Nature play" represented by item no.: NRO409-0621.

(Scope 3 emissions include emission sources in the upstream and downstream value chain).

Date: 30. October 2023 | Valid until: 30. October 2025

Verified by:

Julie Marie Vejsgaard Larsen, LCA & EPD Consultant

Verification based on report: Validation of CO₂ calculation of 9 categories of Kompan product line, version 1.0, prepared by: Bureau Veritas HSE, Denmark: Julie M. V. Larsen.

Publication date: 30. October 2023

By Bureau Veritas HSE
 www.bureauveritas.dk
 +45 7731 1000



Niagara

NAT527

* Max fall height | ** Total height | *** Safety surfacing area

* Max fall height | ** Total height

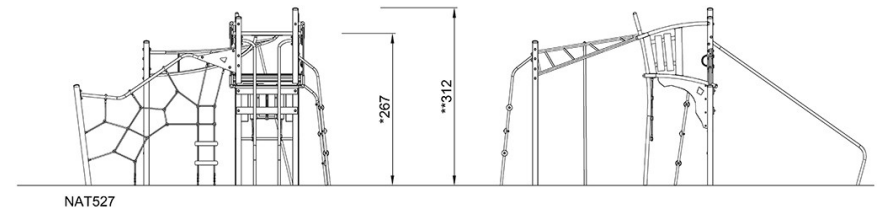
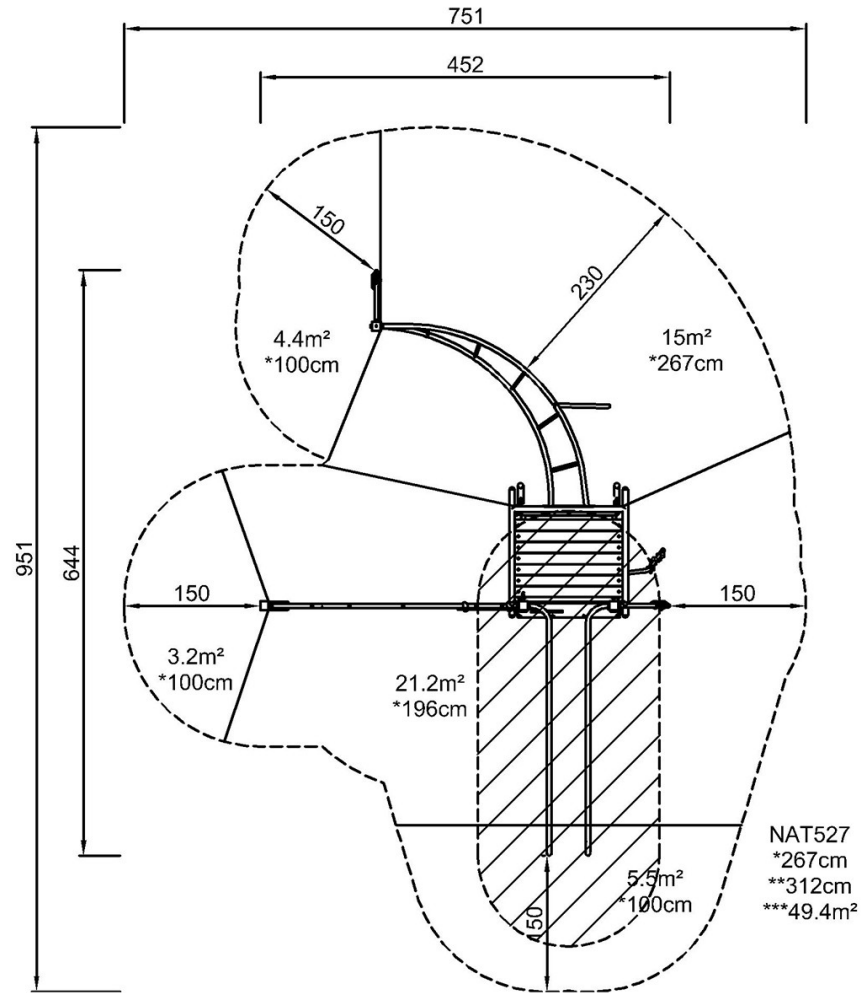

[Click to see TOP VIEW](#)

[Click to see SIDE VIEW](#)