

Cross Training Pro Combi 1

FAZ201

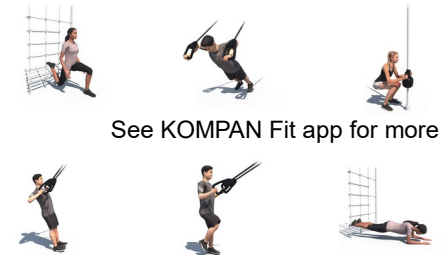

Item no. FAZ20100-0900	
General Product Information	
Dimensions LxWxH	1050x106x334 cm
Age group	13+
Play capacity (users)	10
Color options	



See KOMPAN Fit app for more



The Multi Net is a great climbing structure with an integrated pull up bar, perfect for performing a broad range of bodyweight exercises. The pull up bar and standing pole are ideal for Street Workout related exercises such as the human flag. An innovative magnetic breaking system in the Magnetic Bells allow the user to increase the resistance by increasing the

speed of movement. The patented system also functions as brake when someone drops the magnetic bells and will reduce the impact significantly. With the suspension trainer everyone can workout at their own level due to the scalable resistance. The intensity of each exercise can be determined simply by adjusting the body position to add more or less resistance.



Cross Training Pro Combi 1

FAZ201

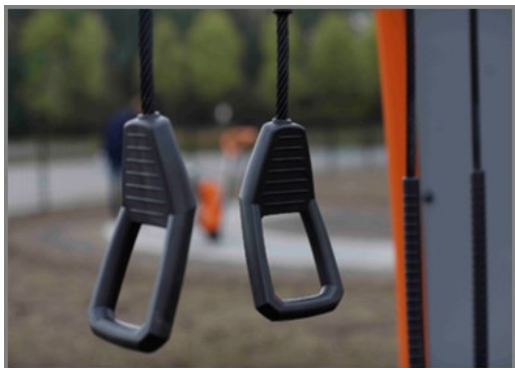

The uniquely designed handles are made of PUR and a reinforced aluminium frame that ensures a strong but light design. The ergonomically shaped handles guarantee a good and pleasant grip for all users.



The big instruction signs are made of a 8mm polycarbonate sheets with clear instructions printed directly on the panels. The polycarbonate is extremely strong and provides a vandalism proof construction.

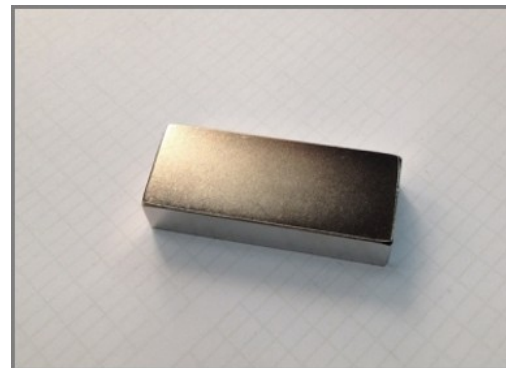

The magnets which are used are High Strength Neodymium magnets. The magnetic radiation is under strict control, the radiation level never exceeds 5 Gauss (0.5mT), which makes them perfectly safe to use as an training item.

Item no. FAZ20100-0900

Installation Information

Max. fall height	286 cm
Safety surfacing area	50.0 m ²
Total installation time	14.4
Excavation volume	1.74 m ³
Concrete volume	0.86 m ³
Footing depth (standard)	90 cm
Shipment weight	856 kg
Anchoring options	In-ground ✓ Surface ✓



The tubes on which the magnetic bells move are ø40mm, made of grade AW 6082-T6 aluminium and have an anodized layer of 20µm. The tube has a full steel core for structural integrity.

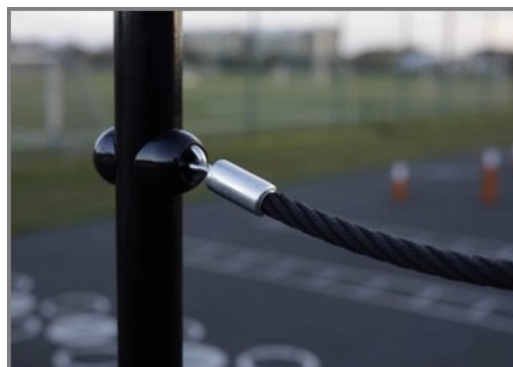

Ropes are made of UV-stabilised PES with inner steel cable reinforcement. The polyester yarn is made from +95% post-consumer materials and is inductively melted onto each strand, leading to good wear resistance.



Each suspension trainer has 3 sets of handles positioned at 3 different heights, 40, 90 and 130cm. This allows people of all lengths to do the exercises and gives the user the opportunity to do over 40 different exercises.



Sustainability Data

FAZ201

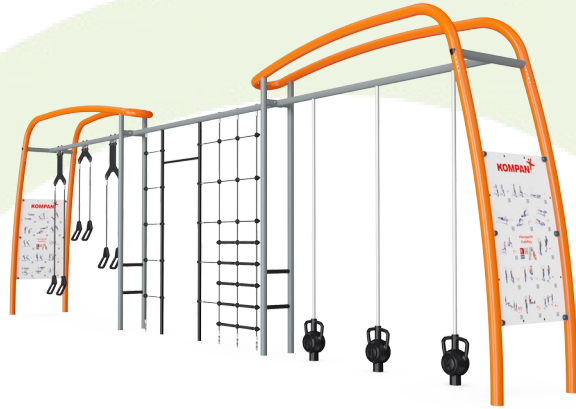

Cradle to Gate A1-A3	Total CO ₂ emission	CO ₂ e/kg	Recycled materials
	kg CO ₂ e	kg CO ₂ e/kg	%
FAZ20100-0900	2,116.00	3.21	43.70

The overall framework applied for these factors is the Environmental Product Declaration (EPD), which quantifies "environmental information on the life cycle of a product and enable comparisons between products fulfilling the same function" (ISO, 2006). This follows the structure and applies a Life-Cycle Assessment approach to the entire Product stage from raw material through manufacturing (A1-A3))

Kompan A/S
 C.F. Tietgens Boulevard 32C
 DK-5220 Odense SØ
 Denmark



Verification of CO₂ calculation of: Fitness



Data version no. 2023-10-05

The CO₂ calculation and data are in compliance with the principles of a carbon footprint impact according to the GHG protocol (Greenhouse Gas Protocol), Scope 3, cradle to gate related to all individual components in the product category: "Fitness" represented by item no.: FAZ10100-0900.

(Scope 3 emissions include emission sources in the upstream and downstream value chain).

Date: 30. October 2023 | Valid until: 30. October 2025

Verified by:

Julie Marie Vejsgaard Larsen, LCA & EPD Consultant

Verification based on report: Validation of CO₂ calculation of 9 categories of Kompan product line, version 1.0, prepared by: Bureau Veritas HSE, Denmark: Julie M. V. Larsen.

Publication date: 30. October 2023

By Bureau Veritas HSE
 www.bureauveritas.dk
 +45 7731 1000



Cross Training Pro Combi 1

FAZ201

* Max fall height | ** Total height | *** Safety surfacing area

* Max fall height | ** Total height

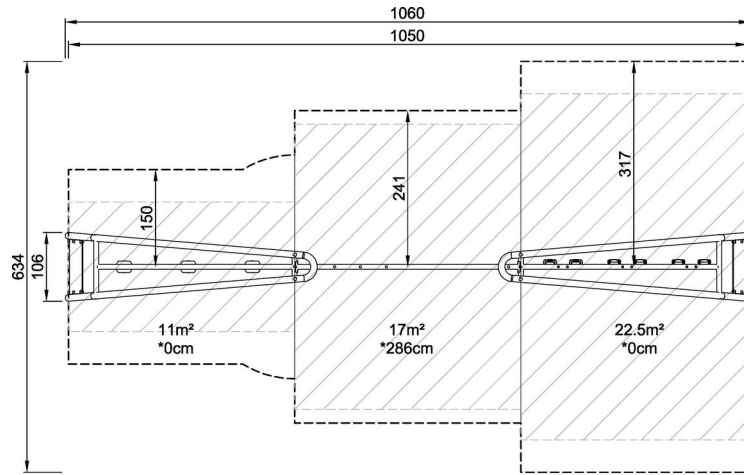

FAZ20100
*286cm
**334cm
***50m²
1:100

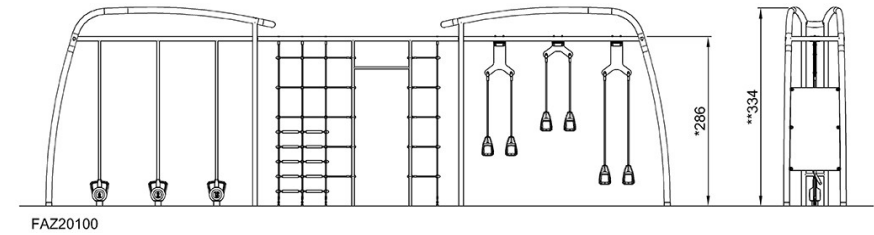

[Click to see TOP VIEW](#)

[Click to see SIDE VIEW](#)