

Playhut with Side & Desks

NRO411

KOMPAN
Let's play



Item no. NRO411-1021

General Product Information

Dimensions LxWxH	180x163x158 cm
Age group	1+
Play capacity (users)	8
Colour options	



A playhut easily attracts in younger children who just want to simply play. The simple yet intentional design and the detail in its features supports and enhances children's play. The wide open space allows for a flow of children in and around the play space. This increases social interactions and supports the children when they are looking for a way to interact with

others comfortably. The roof provides a sheltered space allowing the children to move in and out of the playhut while using their imagination. The fenced section of the house also creates an additional opportunity for play and movement around the playhut. The children can use this area to talk, socialise, to pass materials such as sand through and to

play hide and seek. The desk area adds another dimension to the play by providing a space for creating play themes that involve exchanges over the desks and through the open window space. All of these activities support a healthy development through play.



Playhut with Side & Desks

NRO411



Theme

Cognitive: suggests a theme and supports dramatic play, which stimulates language and communication skills.



Bench

Social-Emotional: invites socializing and cooperation. Allows for a break with friends.



Desk

Social-Emotional: great meeting place and space creator for storing or sitting.

Playhut with Side & Desks

NRO411



All Organic Robinia products by KOMPAN are made of Robinia wood from sustainable European sources. On request it can be supplied as FSC® Certified (FSC® C004450).



The product/activities are preassembled from the factory to ensure all safety requirements are considered.



The paint used for coloured components is water based environmentally friendly with excellent UV resistance. The paint is in compliance with EN 71 Part 3.

Item no. NRO411-1021	
Installation Information	
Max. fall height	0 cm
Safety surfacing area	17.1 m ²
Total installation time	5.6
Excavation volume	0.63 m ³
Concrete volume	0.00 m ³
Footing depth (standard)	100 cm
Shipment weight	261 kg
Anchoring options	In-ground ✓
Warranty Information	
EcoCore HDPE	Lifetime
Hot dip galvanised steel	Lifetime
Robinia wood	15 years
Spare parts guaranteed	10 years
Stainless steel components	Lifetime



The playhouses are available with floor inside the house and with a floor outside to create a porch.



There are Multiple footing options for all products: Surface anchoring with steel footings and expansion bolts. Wood in-ground or steel in-ground footings.



Robinia products are available in three different wood treatment options: Untreated Robinia wood or brown painted with a pigment that maintains the wood colour and coloured version with paint of selected components.



Sustainability Data

NRO411



Cradle to Gate A1-A3	Total CO ₂ emission	CO ₂ e/kg	Recycled materials
	kg CO ₂ e	kg CO ₂ e/kg	%
NRO411-1021	35.97	0.17	0.78

The overall framework applied for these factors is the Environmental Product Declaration (EPD), which quantifies "environmental information on the life cycle of a product and enable comparisons between products fulfilling the same function" (ISO, 2006). This follows the structure and applies a Life-Cycle Assessment approach to the entire Product stage from raw material through manufacturing (A1-A3))

Kompan A/S
 C.F. Tietgens Boulevard 32C
 DK-5220 Odense SØ
 Denmark



Verification of CO₂ calculation of: Nature play



Data version no. 2023-10-05

The CO₂ calculation and data are in compliance with the principles of a carbon footprint impact according to the GHG protocol (Greenhouse Gas Protocol), Scope 3, cradle to gate related to all individual components in the product category: "Nature play" represented by item no.: NRO409-0621.

(Scope 3 emissions include emission sources in the upstream and downstream value chain).

Date: 30. October 2023 | Valid until: 30. October 2025

Verified by:

Julie Marie Vejsgaard Larsen, LCA & EPD Consultant

Verification based on report: Validation of CO₂ calculation of 9 categories of Kompan product line, version 1.0, prepared by: Bureau Veritas HSE, Denmark: Julie M. V. Larsen.

Publication date: 30. October 2023

By Bureau Veritas HSE
 www.bureauveritas.dk
 +45 7731 1000



Playhut with Side & Desks

NRO411

* Max fall height | ** Total height | *** Safety surfacing area

* Max fall height | ** Total height

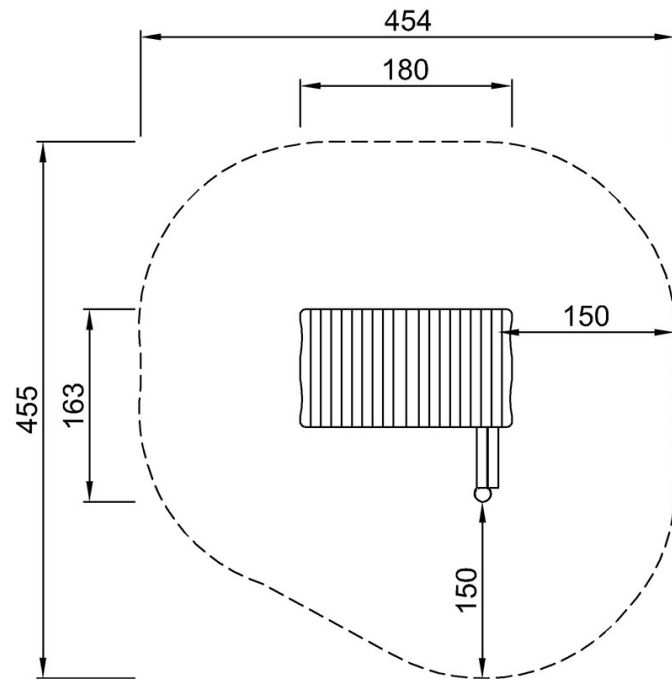

NRO411
**158cm
***17.1m²

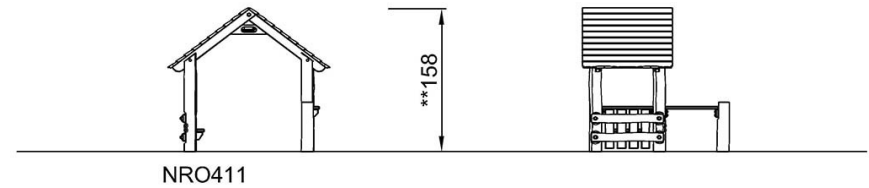

[Click to see TOP VIEW](#)

[Click to see SIDE VIEW](#)