

# Peekaboo Tunnel

PCM002921



Item no. PCM002921-0601	
<b>General Product Information</b>	
Dimensions LxWxH	87x160x100 cm
Age group	6m+
Play capacity (users)	3
Colour options	



Peek-a-boo games are classic fun for young children and are natural learning opportunities. The peek-a-boo tunnel encourages these games which help the younger children to explore concepts related to object awareness (people and objects remain present after we cannot see them) as well as perspective and how pure fun is related to surprise. The tunnel

also supports the physical dimension of this kind of play by encouraging crawling through and moving around. This helps to develop motor skills such as coordination and awareness. The holes in the tunnel allows for interaction with the children on ground level. The structure also supports dramatic play and imagination and stimulates language and

communication skills in the children. Lots of play in a simple structure, designed with play in mind.

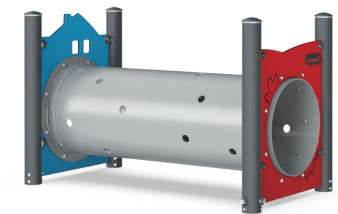

# Peekaboo Tunnel

PCM002921

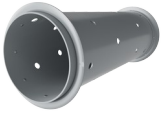

## Tunnel

**Physical:** the children crawl through the tunnel, developing motor skills such as cross-body coordination and proprioception. **Social-Emotional:** turn-taking when passing each other.



# Peekaboo Tunnel

PCM002921



Panels of 19mm EcoCore™. EcoCore™ is a highly durable, eco friendly material, which is not only recyclable after use, but also consists of material produced from +95% recycled post consumer material from food packing waste.



Main posts with hot dip galvanized steel footing are available in different materials: Pressure impregnated pine wood posts. Pre-galvanized inside and outside with powder coated top finish steel posts. Lead free aluminum with color anodized top finish. Greenline TexMade posts of 95% post-consumer recycled PE and textile waste.

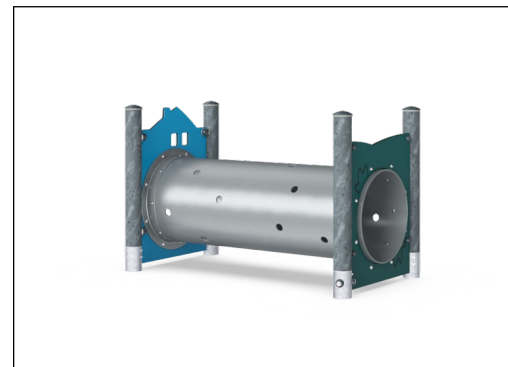

KOMPAN GreenLine versions are designed with ultimate environmentally friendly materials with lowest possible CO2e emission factor such as EcoCore™ panels of +95% post consumer recycled ocean waste.

Item no. PCM002921-0601

### Installation Information

Max. fall height	15 cm
Safety surfacing area	14.2 m <sup>2</sup>
Total installation time	4.6
Excavation volume	0.08 m <sup>3</sup>
Concrete volume	0.00 m <sup>3</sup>
Footing depth (standard)	60 cm
Shipment weight	96 kg
Anchoring options	In-ground ✓ Surface ✓

### Warranty Information

EcoCore HDPE	Lifetime
Post	10 years
Spare parts guaranteed	10 years



# Sustainability Data

PCM002921

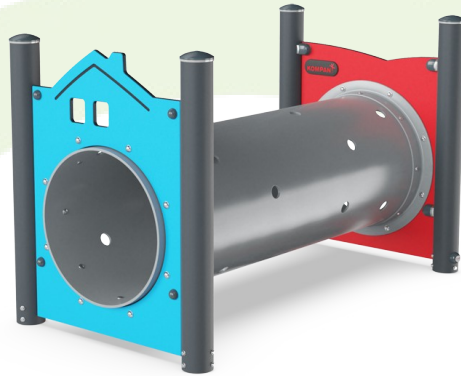

Cradle to Gate A1-A3	Total CO <sub>2</sub> emission	CO <sub>2</sub> e/kg	Recycled materials
	kg CO <sub>2</sub> e	kg CO <sub>2</sub> e/kg	%
<b>PCM002921-0650</b>	152.34	1.81	63.48
<b>PCM002921-0601</b>	181.88	2.49	49.29

The overall framework applied for these factors is the Environmental Product Declaration (EPD), which quantifies "environmental information on the life cycle of a product and enable comparisons between products fulfilling the same function" (ISO, 2006). This follows the structure and applies a Life-Cycle Assessment approach to the entire Product stage from raw material through manufacturing (A1-A3))

**Kompan A/S**  
 C.F. Tietgens Boulevard 32C  
 DK-5220 Odense SØ  
 Denmark



## Verification of CO<sub>2</sub> calculation of: Themed play systems



Data version no. 2023-10-05

The CO<sub>2</sub> calculation and data are in compliance with the principles of a carbon footprint impact according to the GHG protocol (Greenhouse Gas Protocol), Scope 3, cradle to gate related to all individual components in the product category: "Themed play systems" represented by item no.: MSC641100-3717P.

(Scope 3 emissions include emission sources in the upstream and downstream value chain).

**Date: 30. October 2023 | Valid until: 30. October 2025**

Verified by:

Julie Marie Vejsgaard Larsen, LCA & EPD Consultant

Verification based on report: Validation of CO<sub>2</sub> calculation of 9 categories of Kompan product line, version 1.0, prepared by: Bureau Veritas HSE, Denmark: Julie M. V. Larsen.

**Publication date: 30. October 2023**

By Bureau Veritas HSE  
 www.bureauveritas.dk  
 +45 7731 1000



# Peekaboo Tunnel

PCM002921

\* Max fall height | \*\* Total height | \*\*\* Safety surfacing area

\* Max fall height | \*\* Total height

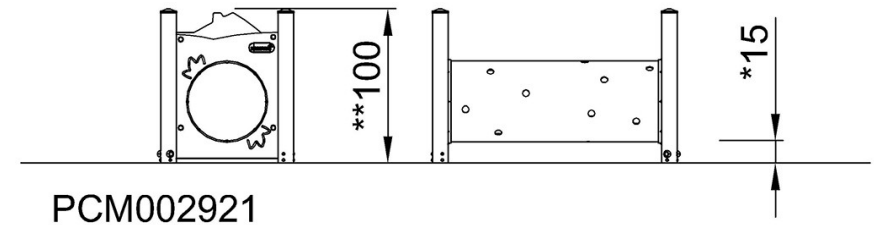
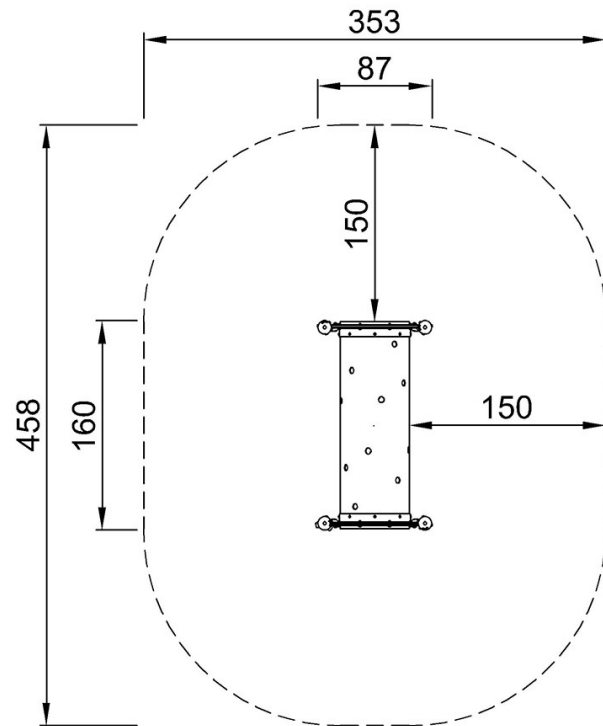

PCM002921  
\*15cm  
\*\*100cm  
\*\*\*14.2m<sup>2</sup>

[Click to see TOP VIEW](#)

[Click to see SIDE VIEW](#)