

Freestanding Slide, 2.0m high

COR66910

KOMPAN
Let's play

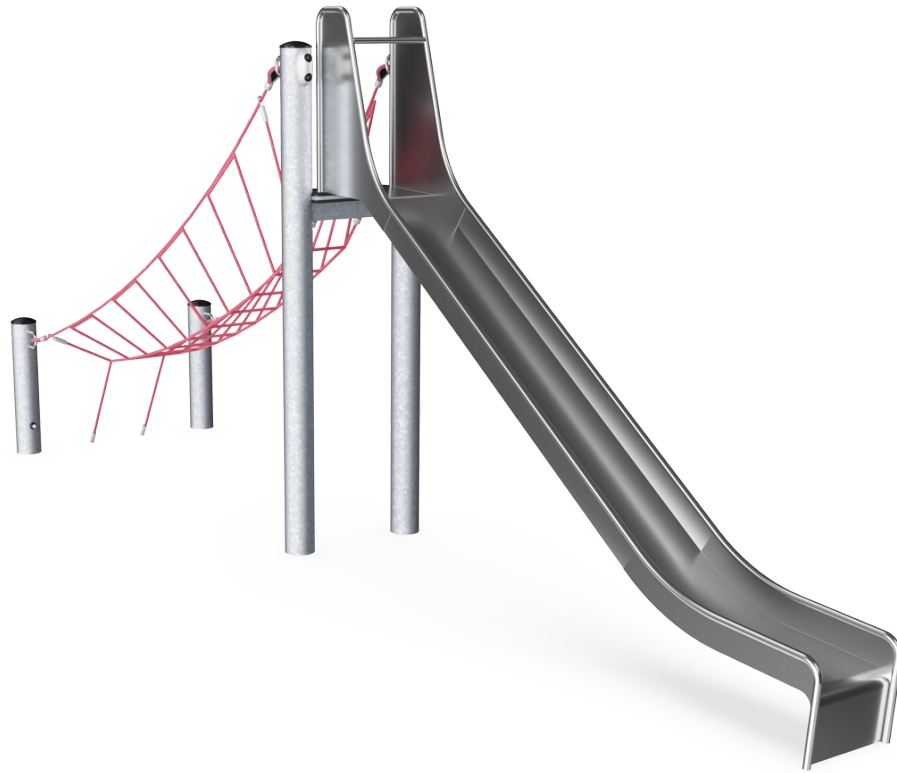

Item no. COR669101-1101

General Product Information

Dimensions LxWxH	680x152x297 cm
Age group	5+
Play capacity (users)	4
Colour options	

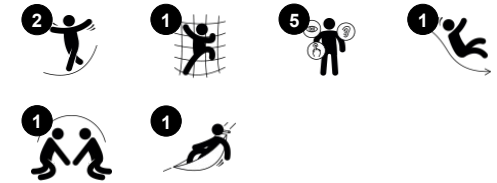

The sturdy 2 meter freestanding slide will inspire children who are eager to play. The pleasing design adds beauty to the playground while also offering challenging climbing along with a thrilling slide down to the ground as a reward. Because the climb is a challenge, and the slide is fast and fun, children will want to play over and over again. This helps to

encourage more physical play on the playground, which strengthens skills such as agility and cross-coordination. Sliding on the slide encourages a sense of balance and posture, in addition to the thrill of taking a risk in a safe environment, which is important for psychological health, resilience and well-being. The high capacity of this slide also supports

social skills such as turn-taking and empathy, as children help each other to be successful in the climb and slide.

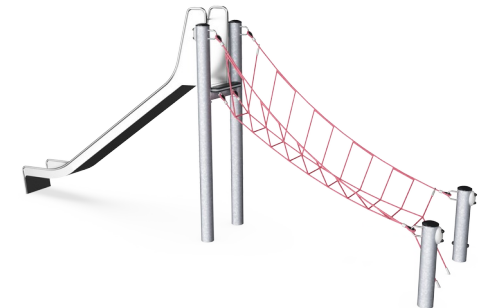

Freestanding Slide, 2.0m high

COR66910

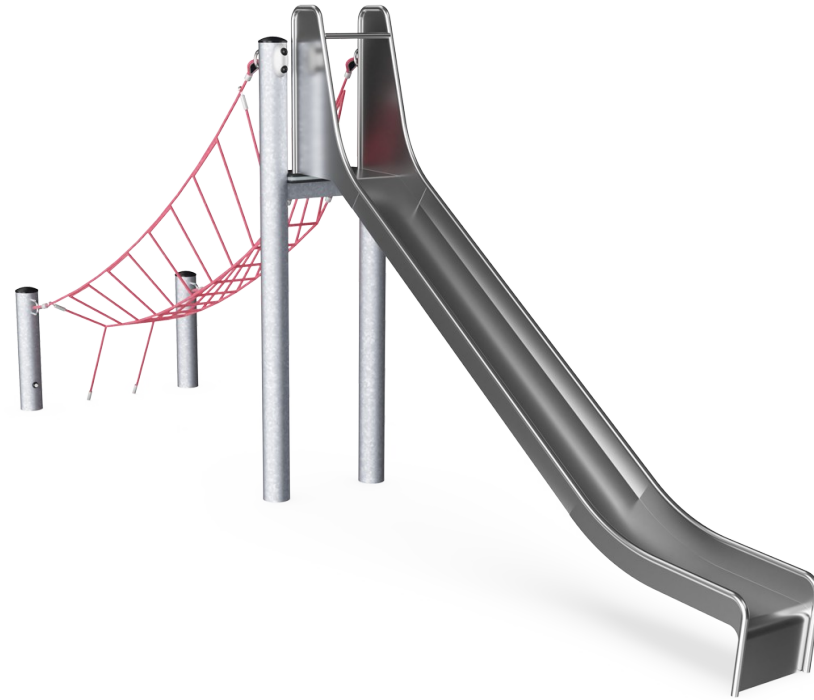

Slide

Physical: sliding develops spatial awareness and a sense of balance. Furthermore, the core muscles are trained when sitting upright going down. **Social-Emotional:** empathy stimulated by turn-taking.



Wobble bridge

Physical: sense of balance and training of cross coordination. Important for other skills such as being able to sit still. **Social-Emotional:** turn-taking and helping others when climbing up.

Freestanding Slide, 2.0m high

COR66910



Ropes of UV-stabilized PES rope strands with inner steel cable reinforcement. The polyester yarn is made from +95% post-consumer materials and is inductively melted onto each strand. The ropes are highly wear-and vandalism-resistant and can be replaced at site if needed.



Corocord 'S' clamps are used as universal connections in Corocord products. 8mm stainless steel rods with rounded edges are pressed around the ropes with a special hydraulic press, making them the ideal connector: safe, durable and vandalism-proof, all while allowing the typical movement of rope play structures.



The steel structure are hot dip galvanized inside and outside with lead free zinc. The galvanisation has excellent corrosion resistance in outside environments and requires low maintenance.



The stainless steel components are made of high quality stainless steel in compliance with global playground standards. The steel is glass blasted after manufacturing to ensure a smooth gliding surface.



Through KOMPAN Variant Team, you can choose between additional 7 rope colours and customize your solution. The assortment is a wide span of colours ranking from elegant and expressive black or natural and toned-down hemp colour, to a range of attractive and eye-catching signal colours.

Item no. COR669101-1101	
Installation Information	
Max. fall height	200 cm
Safety surfacing area	40.6 m ²
Total installation time	9.3
Excavation volume	4.63 m ³
Concrete volume	2.95 m ³
Footing depth (standard)	110 cm
Shipment weight	555 kg
Anchoring options	In-ground ✓
Warranty Information	
Corocord rope	10 years
Hot dip galvanized steel	Lifetime
S-Clamps	10 years
Spare parts guaranteed	10 years



Sustainability Data

COR66910

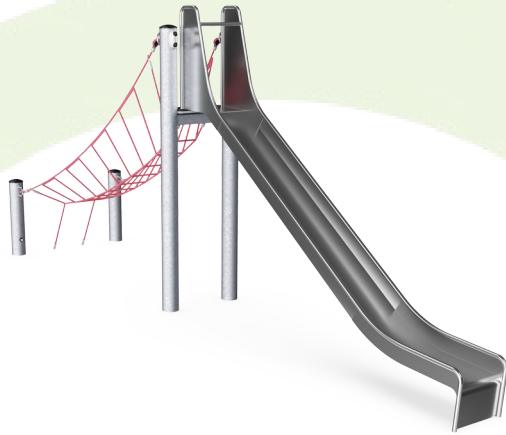

Cradle to Gate A1-A3	Total CO ₂ emission	CO ₂ e/kg	Recycled materials
	kg CO ₂ e	kg CO ₂ e/kg	%
COR669101-1101	1,029.10	2.92	54.39

The overall framework applied for these factors is the Environmental Product Declaration (EPD), which quantifies "environmental information on the life cycle of a product and enable comparisons between products fulfilling the same function" (ISO, 2006). This follows the structure and applies a Life-Cycle Assessment approach to the entire Product stage from raw material through manufacturing (A1-A3))

Kompan A/S
 C.F. Tietgens Boulevard 32C
 DK-5220 Odense SØ
 Denmark



Verification of CO₂ calculation of: Corocord



Data version no. 2023-10-05

The CO₂ calculation and data are in compliance with the principles of a carbon footprint impact according to the GHG protocol (Greenhouse Gas Protocol), Scope 3, cradle to gate related to all individual components in the product category: "Corocord" represented by item no.: COR314011-1101.

(Scope 3 emissions include emission sources in the upstream and downstream value chain).

Date: 30. October 2023 | Valid until: 30. October 2025

Verified by:

Julie Marie Vejsgaard Larsen, LCA & EPD Consultant

Verification based on report: Validation of CO₂ calculation of 9 categories of Kompan product line, version 1.0, prepared by: Bureau Veritas HSE, Denmark: Julie M. V. Larsen.

Publication date: 30. October 2023

By Bureau Veritas HSE
 www.bureauveritas.dk
 +45 7731 1000



Freestanding Slide, 2.0m high

COR66910

* Max fall height | ** Total height | *** Safety surfacing area

* Max fall height | ** Total height

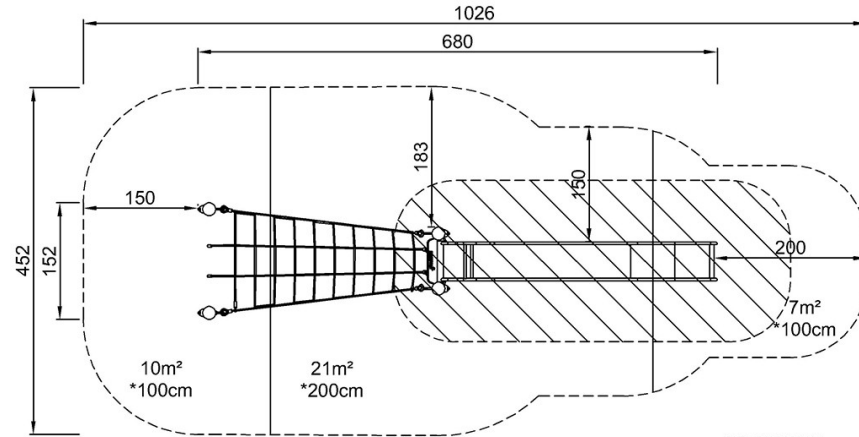

COR669101
*200cm
**297cm
***38m²

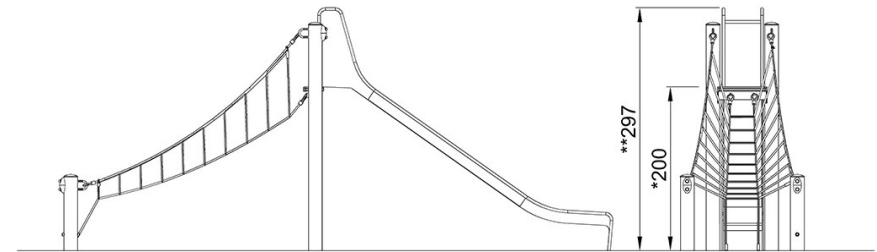

COR669101

[Click to see TOP VIEW](#)

[Click to see SIDE VIEW](#)