

Combi 4 met Multi Timer

FSW302

KOMPAN
Let's play



Item nummer FSW30200-0901

Algemene Product Informatie

Afmetingen LxBxH	416x456x240 cm
Leeftijdsgroep	13+
Speelcapaciteit	4
Kleuropties	



Meer op KOMPAN Fit app



De Multi Timer is een betrouwbaar middel om tijdens het trainen de tijden bij te houden. Je workouts meten en structureren werkt heel motiverend. Daarnaast kun je op basis van de gegevens je workouts aanpassen om continu vooruitgang te boeken en je uiteindelijke doel te bereiken. De gegevens op de Multi Timer zijn tijdens het trainen duidelijk zichtbaar. De

timer geeft een auditief en visueel signaal dat het begin en einde van activiteiten aangeeft. Er zijn 5 timerfuncties 1. Stopwatch 2. Tabata Timer (20/10 sec) 3 Interval Timer (30/10 sec) 4. HIIT (40/20 sec) 5. EMOM (60 sec)

Combi 4 met Multi Timer

FSW302

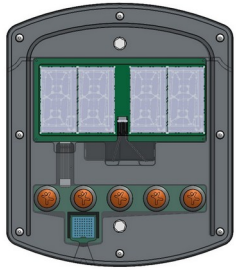

The reflective LCD display has four digits of 100mm height, with excellent outdoor visibility and a wide viewing angle. An LCD display has a low energy consumption, It is powered by 8 replaceable AA batteries with a lifespan of more than 2 years.

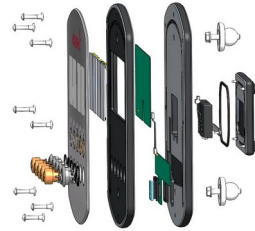

Front panels are made of UV-stabilized Polycarbonate. The UV-stabilization prevents the Transparent panels in being yellow over time and ensures the mechanical performances. The graphic prints are added by a unique multi-layer print process where the inner layer is the image and outer transparent layer functions as protection. The lacquer is water-based, and UV stabilized to prevent fading.



The push buttons and the housing for the push buttons are made from Polyamide (PA6). The buttons contain a magnet which activates a contactless reed switch when the buttons are pushed. This ensures high durability of the system.



The connectors are made of die-cast aluminum specially alloyed for outdoor environments and with a lead content below 100ppm. The connectors are attached to the posts by stainless steel screws and well protected against corrosion by special designed zinc washers. Extremely strong and no change of corrosion.



Steel posts are made of Ø101,6 x 2,0mm pre-galvanized steel tube. The posts are powder coated. Tops of posts are sealed with plastic caps (PA6). Footings for surface installation are manufactured from Carbon steel with hot-dip galvanized surface according to ISO1461.

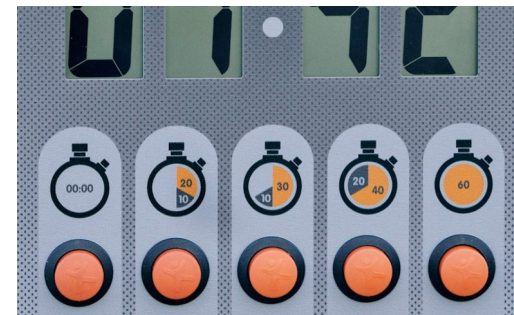

There are 5 timer functions 1. Stopwatch 2. Tabata Timer (20/10 sec) 3. Interval Timer (30/10 sec) 4. HIIT (40/20 sec) 5. EMOM (60 sec)

Item nummer FSW30200-0901	
Installatie informatie	
Max. valhoogte	233 cm
Veiligheidszone	42,4 m ²
Totale installatietijd	9,0
Graafwerk (vol.)	0,88 m ³
Benodigd beton	0,42 m ³
Verankeringsdiepte	90 cm
Verzendingsgewicht	380 kg
Verankeringsopties	In-ground ✓ Oppervlak ✓
Garantie informatie	
Aluminium klemmen	10 jaar
Gecoate stalen onderdelen	10 jaar
EcoCore HDPE	Levenslang
Elektronica	2 jaar
Gegarandeerde reserveonderdelen	10 jaar



Sustainability Data

FSW302



Cradle to Gate A1-A3	Total CO ₂ emission	CO ₂ e/kg	Recycled materials
	kg CO ₂ e	kg CO ₂ e/kg	%
FSW30200-0901	509,47	2,14	64,13

The overall framework applied for these factors is the Environmental Product Declaration (EPD), which quantifies "environmental information on the life cycle of a product and enable comparisons between products fulfilling the same function" (ISO, 2006). This follows the structure and applies a Life-Cycle Assessment approach to the entire Product stage from raw material through manufacturing (A1-A3))

Kompan A/S
 C.F. Tietgens Boulevard 32C
 DK-5220 Odense SØ
 Denmark



Verification of CO₂ calculation of: Fitness



Data version no. 2023-10-05

The CO₂ calculation and data are in compliance with the principles of a carbon footprint impact according to the GHG protocol (Greenhouse Gas Protocol), Scope 3, cradle to gate related to all individual components in the product category: "Fitness" represented by item no.: FAZ10100-0900.

(Scope 3 emissions include emission sources in the upstream and downstream value chain).

Date: 30. October 2023 | Valid until: 30. October 2025

Verified by:

Julie Marie Vejsgaard Larsen, LCA & EPD Consultant

Verification based on report: Validation of CO₂ calculation of 9 categories of Kompan product line, version 1.0, prepared by: Bureau Veritas HSE, Denmark: Julie M. V. Larsen.

Publication date: 30. October 2023

By Bureau Veritas HSE
 www.bureauveritas.dk
 +45 7731 1000



Combi 4 met Multi Timer

FSW302

Max. valhoogte | Totale Hoogte | Veiligheidszone

Max. valhoogte | Totale Hoogte

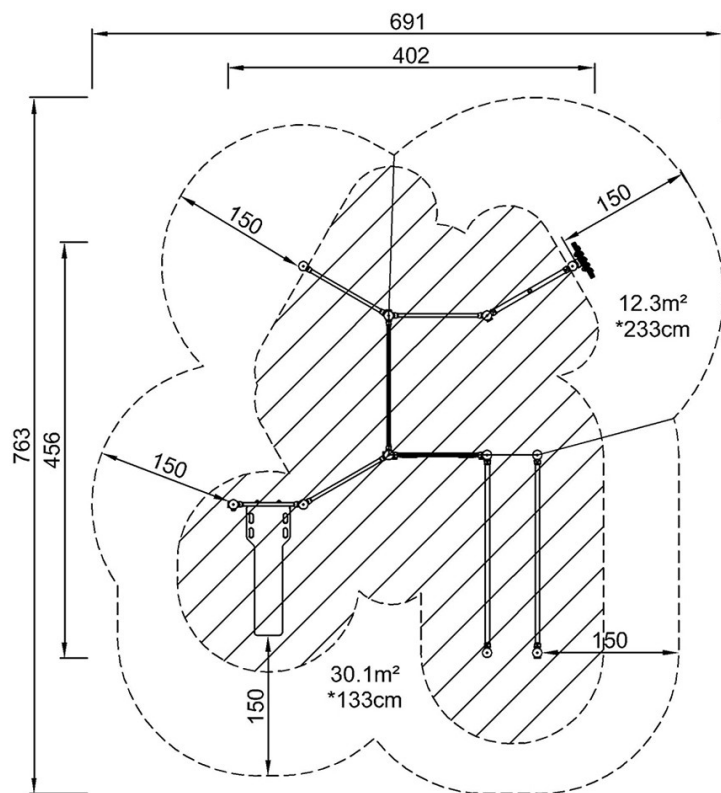

FSW30200
*233cm
**240cm
***42.4m²

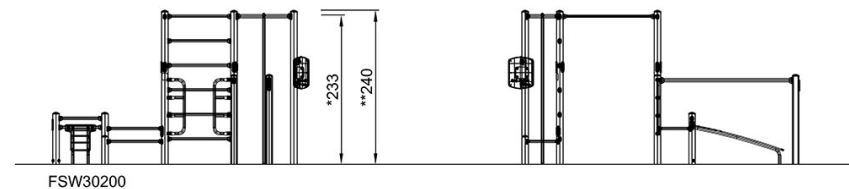

[Bekijk BOVENAANZICHT](#)

[Bekijk ZIJAANZICHT](#)