



# Balance Poles

NRO817



Item no. NRO817-1001	
<b>General Product Information</b>	
Dimensions LxWxH	229x50x260 cm
Age group	4+
Play capacity (users)	2
Colour options	 

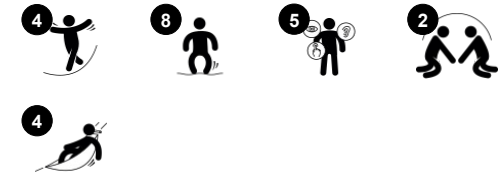

The Balance Poles are wonderful climbing, seating and meeting ropes that children will want to try out repeatedly. One of the reasons is that they move when climbed and balanced. Children love the responsive play more than anything. They will balance across the four ropes of the Balance Poles and train their balance and proprioception while doing so.

Balance and proprioception are fundamental in confidently managing the body in its surroundings. This is important for instance when navigating street traffic safely, but it also plays an important role for children's self confidence. Climbing across the Balance Poles with friends also encourages children to learn how to take it in turns. These are important

social-emotional skills that are basic to the ability to form friendship and relate to peers.

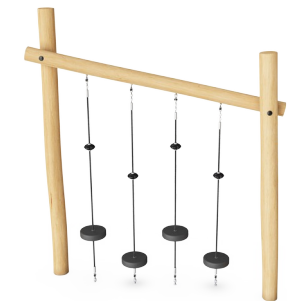

# Balance Poles

NRO817



## Parkour ropes

**Physical:** the big rubbery discs are great support for the feet when climbing or crossing. This trains cross coordination, balance and arm and leg muscles. This combination adds to the child's body adeptness and awareness, adding security to movements. **Social-Emotional:** the seats make a nice destination and meeting point and take cooperation when crossing by others on the way through the module.



# Balance Poles

NRO817



All Organic Robinia products by KOMPAN are made of Robinia wood from sustainable European sources. On request it can be supplied as FSC® Certified (FSC® C004450).



Full coloured EPDM rubber seats with smooth surface. The seats are moulded on a hot dip galvanised steel inlay that ensures durable fixation to the rope.



Nets and ropes are made of UV-stabilised PA with inner steel cable reinforcement. The rope is induction treated in order to create a strong connection between steel and rope which leads to good wear resistance.

Item no. NRO817-1001	
Installation Information	
Max. fall height	58 cm
Safety surfacing area	15.6 m <sup>2</sup>
Total installation time	4.5
Excavation volume	0.78 m <sup>3</sup>
Concrete volume	0.06 m <sup>3</sup>
Footing depth (standard)	100 cm
Shipment weight	209 kg
Anchoring options	In-ground ✓
Warranty Information	
EPDM components	2 years
Robinia wood	15 years
Ropes & nets	10 years
Spare parts guaranteed	10 years



The Robinia wood can be supplied as untreated raw wood or painted with a brown coloured transparent pigment that maintains the golden wood colour of the wood.



# Sustainability Data

NRO817

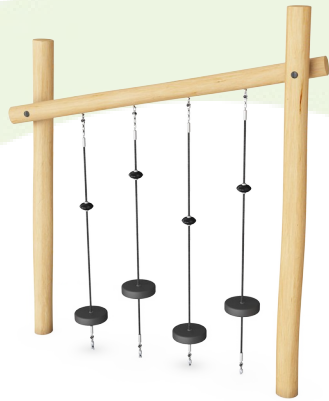

Cradle to Gate A1-A3	Total CO <sub>2</sub> emission	CO <sub>2</sub> e/kg	Recycled materials
	kg CO <sub>2</sub> e	kg CO <sub>2</sub> e/kg	%
NRO817-1001	87.77	0.52	4.46

The overall framework applied for these factors is the Environmental Product Declaration (EPD), which quantifies "environmental information on the life cycle of a product and enable comparisons between products fulfilling the same function" (ISO, 2006). This follows the structure and applies a Life-Cycle Assessment approach to the entire Product stage from raw material through manufacturing (A1-A3))

**Kompan A/S**  
 C.F. Tietgens Boulevard 32C  
 DK-5220 Odense SØ  
 Denmark



## Verification of CO<sub>2</sub> calculation of: Nature play



Data version no. 2023-10-05

The CO<sub>2</sub> calculation and data are in compliance with the principles of a carbon footprint impact according to the GHG protocol (Greenhouse Gas Protocol), Scope 3, cradle to gate related to all individual components in the product category: "Nature play" represented by item no.: NRO409-0621.

(Scope 3 emissions include emission sources in the upstream and downstream value chain).

**Date: 30. October 2023 | Valid until: 30. October 2025**

**Verified by:**

Julie Marie Vejsgaard Larsen, LCA & EPD Consultant

Verification based on report: Validation of CO<sub>2</sub> calculation of 9 categories of Kompan product line, version 1.0, prepared by: Bureau Veritas HSE, Denmark: Julie M. V. Larsen.

**Publication date: 30. October 2023**

By Bureau Veritas HSE  
 www.bureauveritas.dk  
 +45 7731 1000



# Balance Poles

NRO817

\* Max fall height | \*\* Total height | \*\*\* Safety surfacing area

\* Max fall height | \*\* Total height

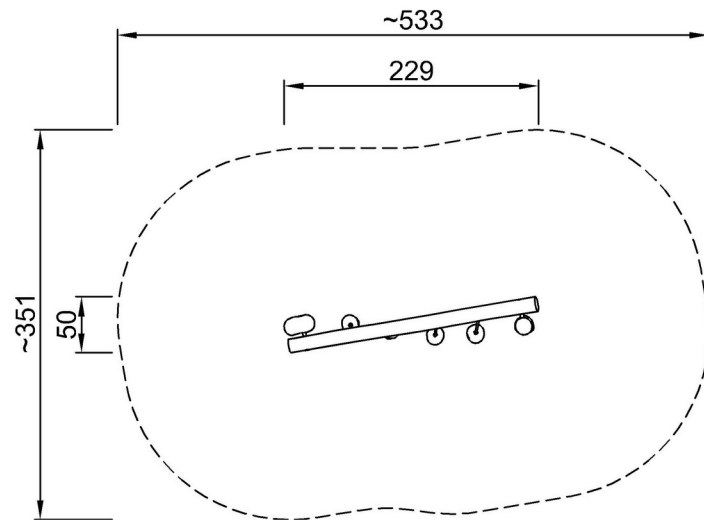

NRO817  
\*58cm  
\*\*260cm  
\*\*\*~15.6m<sup>2</sup>

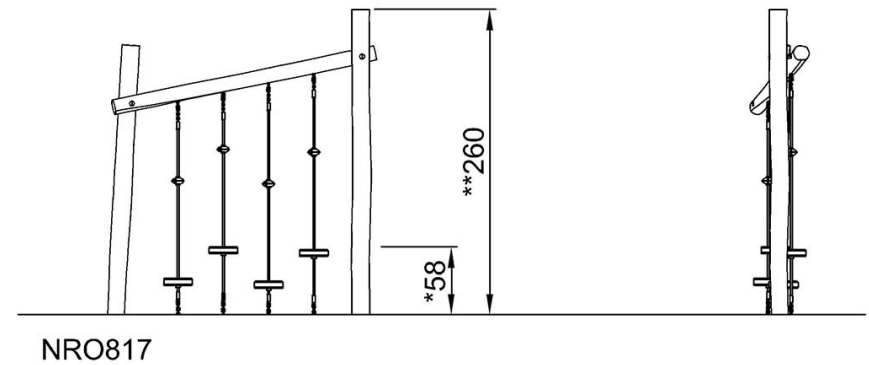

[Click to see TOP VIEW](#)

[Click to see SIDE VIEW](#)