

Stretch Station

FSW223

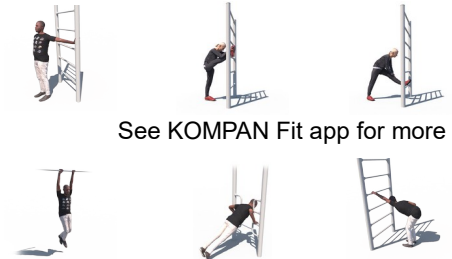

Item no. FSW22300-0902	
General Product Information	
Dimensions LxWxH	119x119x200 cm
Age group	13+
Play capacity (users)	4
Color options	



See KOMPAN Fit app for more



The stretch station invites to several body weight strength and stretch exercises for all difficulty levels. Shoulders and torso can be stretched in all relevant angles independently of individual flexibility. Lower limbs can be stretched by placing the feet on the lowest bars or on the ground with hand support on the bars. Or for more challenging stretches, feet

can be placed on higher bars. Also, when physiotherapists are involved, the stretch station is a perfect mount for elastic bands.



Stretch Station

FSW223



The information sign is made of a PA6 (Polyamide) and shows the most relevant exercise and a QR code. When scanned the QR code will link to an animated illustration of the exercise and offers the possibility of downloading the KOMPAN sport & fitness App, which will provide a large amount of exercises and workouts.



The connectors are made of die-cast aluminium, specially alloyed for the outdoor environments and heavy usage. The screws attaching the connectors are stainless steel and protected by zinc washers.

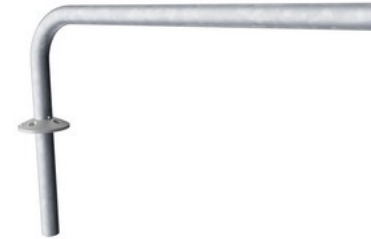

Handrail intended as grips during exercises are made of hot-dip galvanised steel $\varnothing 38\text{mm}$, a great diameter for a good grip and to support the wrist. The height of the handrail is 940mm from the top of the HPL plate. The distance between the rails is 900mm.

Item no. FSW22300-0902

Installation Information

Max. fall height	93 cm
Safety surfacing area	14.0 m ²
Total installation time	4.0
Excavation volume	0.71 m ³
Concrete volume	0.38 m ³
Footing depth (standard)	90 cm
Shipment weight	132 kg
Anchoring options	In-ground ✓ Surface ✓



The handles offer 4 different heights to place the hands or feet



Post are made of $\varnothing 101.6 \times 2\text{mm}$, pre-galvanized carbon steel and powder coated, a great protection to all conditions.



All KOMPAN fitness products are compliant with the ASTM F3101 & EN16630 Outdoor Fitness Standards. Load tests are performed as a static test by adding dynamic factors as well as safety factors to the specified load of 78kg per user. A product intended for 1 user is loaded with 420kg.



Sustainability Data

FSW223



Cradle to Gate A1-A3	Total CO ₂ emission	CO ₂ e/kg	Recycled materials
	kg CO ₂ e	kg CO ₂ e/kg	%
FSW22300-0902	295.82	3.62	47.45

The overall framework applied for these factors is the Environmental Product Declaration (EPD), which quantifies "environmental information on the life cycle of a product and enable comparisons between products fulfilling the same function" (ISO, 2006). This follows the structure and applies a Life-Cycle Assessment approach to the entire Product stage from raw material through manufacturing (A1-A3))

Kompan A/S
C.F. Tietgens Boulevard 32C
DK-5220 Odense SØ
Denmark



Verification of CO₂ calculation of: Fitness



Data version no. 2023-10-05

The CO₂ calculation and data are in compliance with the principles of a carbon footprint impact according to the GHG protocol (Greenhouse Gas Protocol), Scope 3, cradle to gate related to all individual components in the product category: "Fitness" represented by item no.: FAZ10100-0900.

(Scope 3 emissions include emission sources in the upstream and downstream value chain).

Date: 30. October 2023 | Valid until: 30. October 2025

Verified by:

Julie Marie Vejsgaard Larsen, LCA & EPD Consultant

Verification based on report: Validation of CO₂ calculation of 9 categories of Kompan product line, version 1.0, prepared by: Bureau Veritas HSE, Denmark: Julie M. V. Larsen.

Publication date: 30. October 2023

By Bureau Veritas HSE
www.bureauveritas.dk
+45 7731 1000



Stretch Station

FSW223

* Max fall height | ** Total height | *** Safety surfacing area

* Max fall height | ** Total height

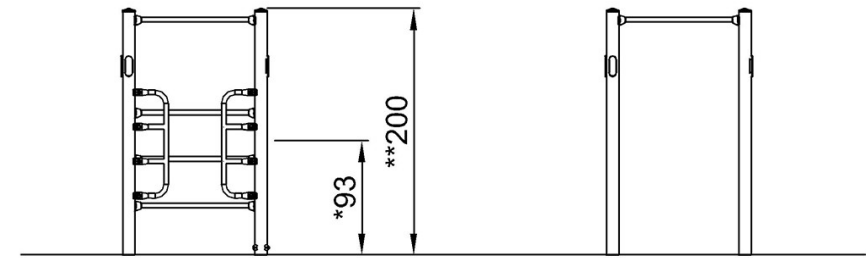
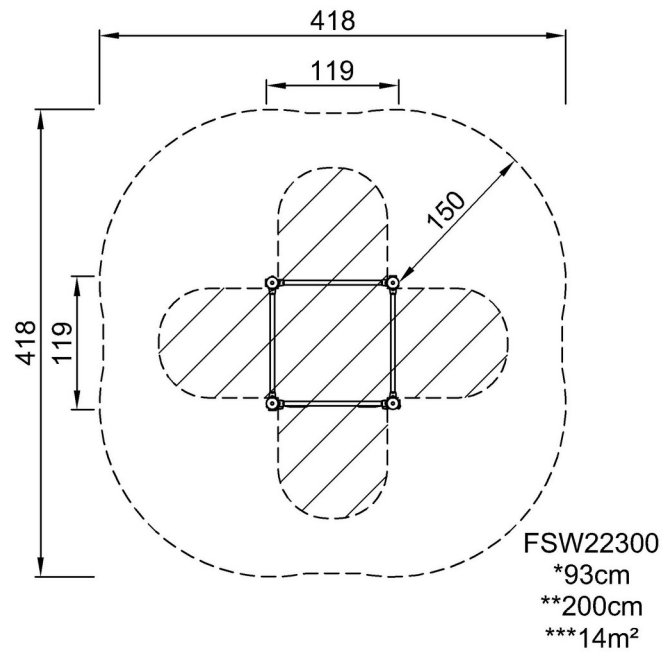

FSW22300

[Click to see TOP VIEW](#)

[Click to see SIDE VIEW](#)