

Performer Arch

CRP800101

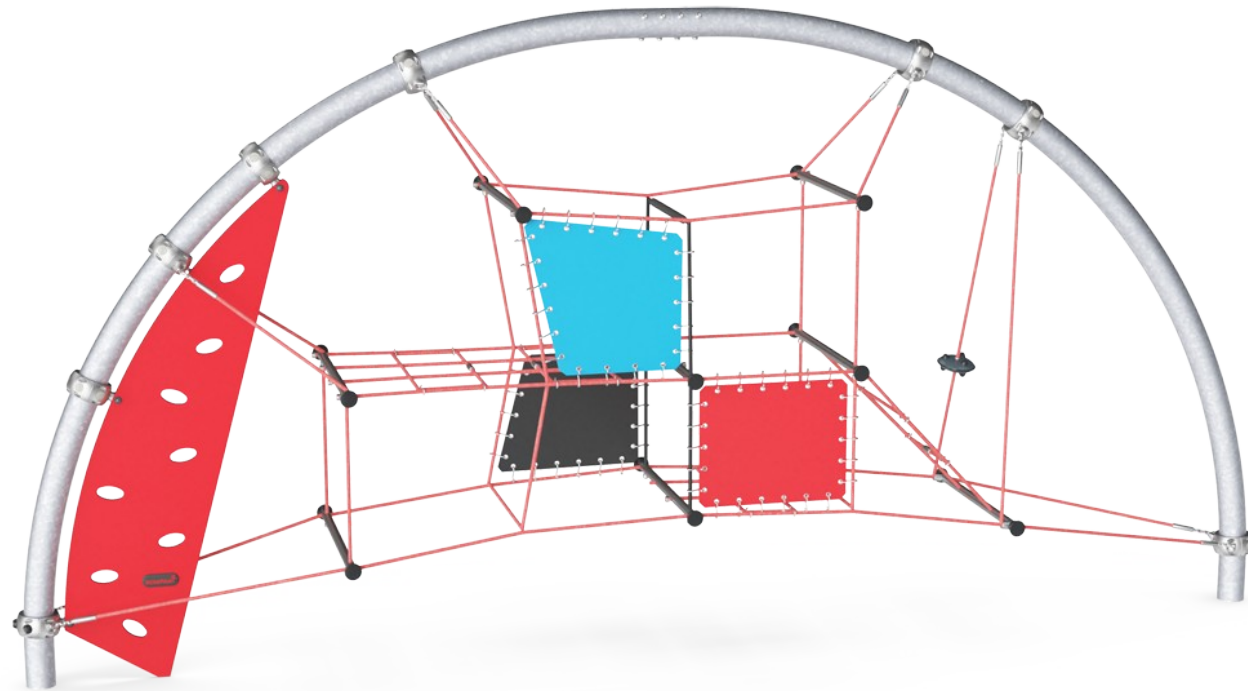

Item no. CRP800101-0901	
General Product Information	
Dimensions LxWxH	622x108x307 cm
Age group	5+
Play capacity (users)	15
Color options	

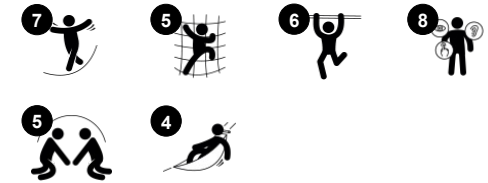

This super exciting structure has a whole range of activities, that will keep children occupied for a long time. The challenges within the structure and the added element of performance play is particularly attractive to older children. The multi-level play also enables many children to play together, strengthening social skills on the playground. The varying play elements enable

a range of activities, which attracts children to play for a longer time. Physical skills, such as agility, balance, and coordination are strengthened through the carefully designed rope activities, that provide varied challenges. This design also supports play across age ranges and abilities because there is something to thrill and challenge everyone,

making effective use of the play space.

Performer Arch

CRP800101

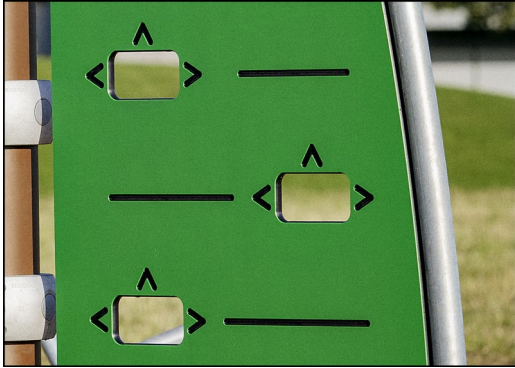

Panels of 19mm EcoCore™. EcoCore™ is a highly durable, eco friendly material, which is not only recyclable after use, but also consists of material produced from +95% recycled post consumer material from food packing waste.

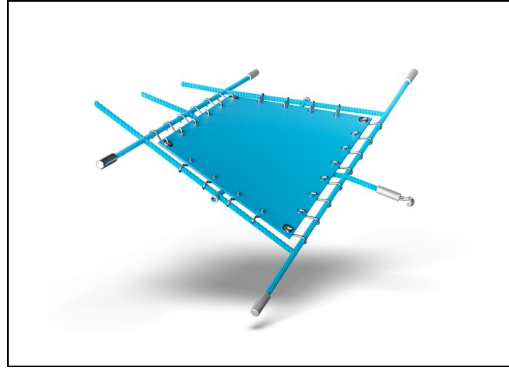

Corocord membranes consist of friction-proof rubberized material of conveyor belt quality with excellent UV resistance. Tested and compliant with REACH requirements for PAH. Embedded is a four-layered armouring made of woven polyester. The armouring and the two surface layers result in a total thickness of 8 mm.



Ropes of UV-stabilized PES rope strands with inner steel cable reinforcement. The polyester yarn is made of +95% Post-consumer materials and is inductively melted onto each strand to obtain excellent wear and tear resistance.

Item no. CRP800101-0901

Installation Information

Max. fall height	225 cm
Safety surfacing area	38.0 m ²
Total installation time	8.7
Excavation volume	4.05 m ³
Concrete volume	2.30 m ³
Footing depth (standard)	90 cm
Shipment weight	523 kg
Anchoring options	

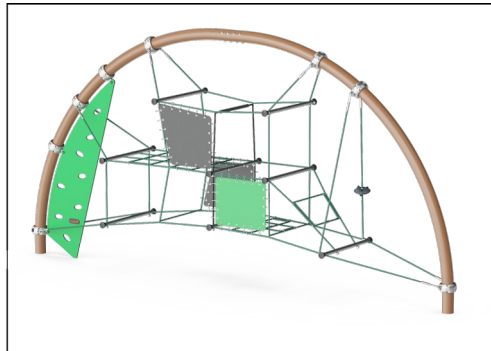

The bended arches are holding the tensioned net structure without additional disturbing fasteners. The arches are produced from high quality stainless steel to allow movement of the net on the surface of the steel arches. The surface is treated to make it shiny.



Corocord 'S' clamps are used as universal connections in Corocord products. 8mm stainless steel rods with rounded edges are pressed around the ropes with a special hydraulic press, making them the ideal connector: safe, durable and vandalism-proof, all while allowing the typical movement of rope play structures.



Corocord smart clamps are carefully designed in every detail to ensure superior flexibility in high quality aluminum material. The smart clamps are attached around the posts with four steel bolts. Not used attachment points are closed with PA caps.

**EN
1176**
compliant

Sustainability Data

CRP800101

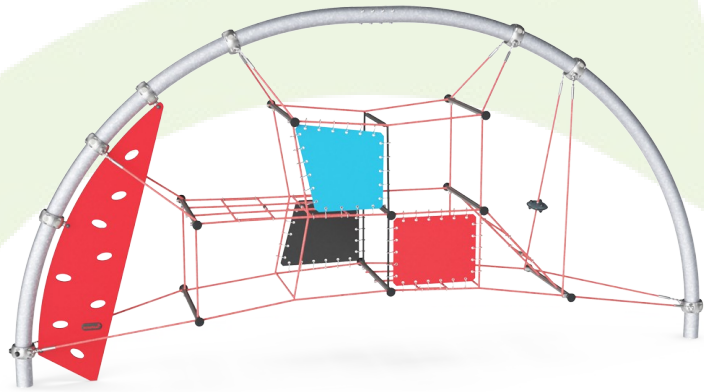

Cradle to Gate A1-A3	Total CO ₂ emission	CO ₂ e/kg	Recycled materials
	kg CO ₂ e	kg CO ₂ e/kg	%
CRP800101-0901	993.90	4.19	39.60

The overall framework applied for these factors is the Environmental Product Declaration (EPD), which quantifies "environmental information on the life cycle of a product and enable comparisons between products fulfilling the same function" (ISO, 2006). This follows the structure and applies a Life-Cycle Assessment approach to the entire Product stage from raw material through manufacturing (A1-A3))

Kompan A/S
 C.F. Tietgens Boulevard 32C
 DK-5220 Odense SØ
 Denmark



Verification of CO₂ calculation of: Corocord



Data version no. 2023-10-05

The CO₂ calculation and data are in compliance with the principles of a carbon footprint impact according to the GHG protocol (Greenhouse Gas Protocol), Scope 3, cradle to gate related to all individual components in the product category: "Corocord" represented by item no.: COR314011-1101.

(Scope 3 emissions include emission sources in the upstream and downstream value chain).

Date: 30. October 2023 | Valid until: 30. October 2025

Verified by:

Julie Marie Vejsgaard Larsen, LCA & EPD Consultant

Verification based on report: Validation of CO₂ calculation of 9 categories of Kompan product line, version 1.0, prepared by: Bureau Veritas HSE, Denmark: Julie M. V. Larsen.

Publication date: 30. October 2023

By Bureau Veritas HSE
 www.bureauveritas.dk
 +45 7731 1000



Performer Arch

CRP800101

* Max fall height | ** Total height | *** Safety surfacing area

* Max fall height | ** Total height

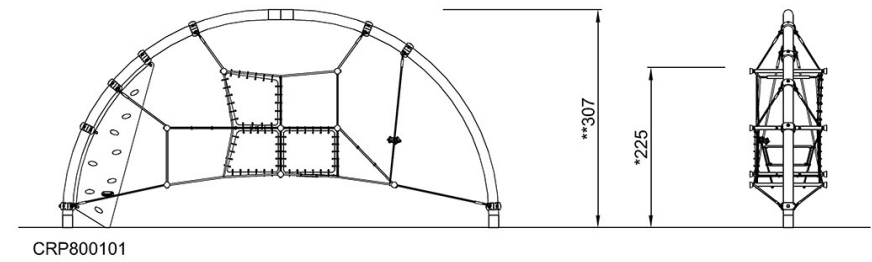
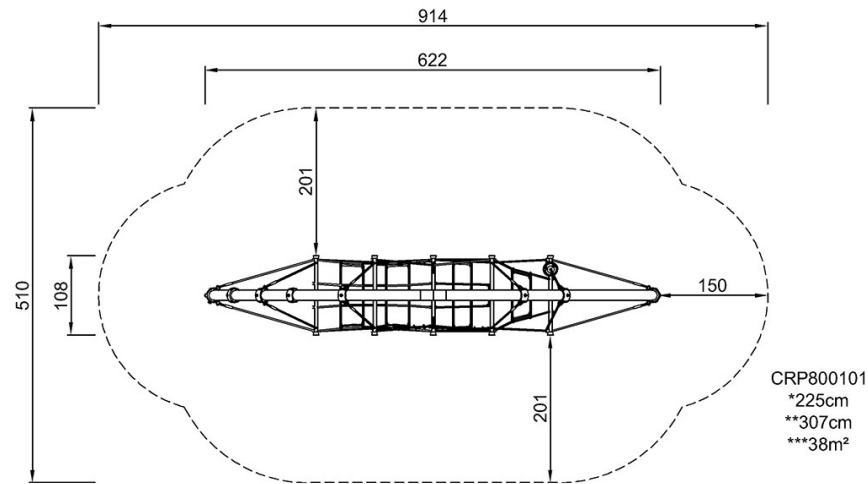

[Click to see TOP VIEW](#)

[Click to see SIDE VIEW](#)