

# Adara II

GXY950

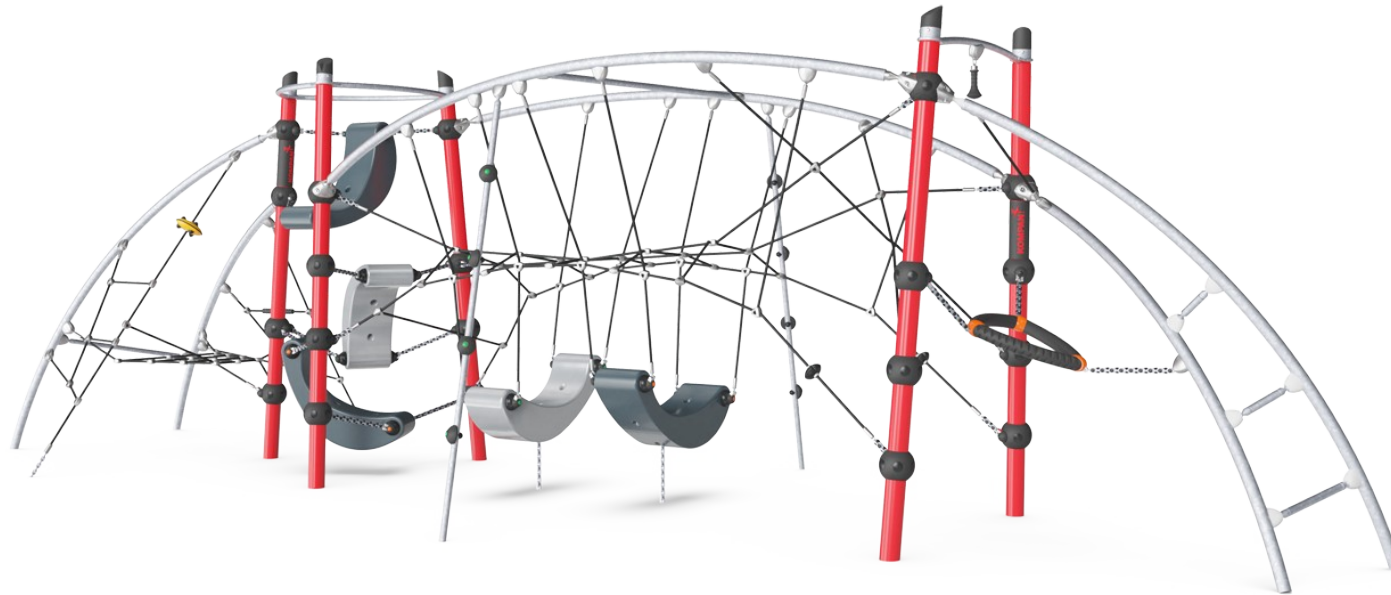

Item no. GXY950032-3717

### General Product Information

Dimensions LxWxH	927x293x265 cm
Age group	6+
Play capacity (users)	21
Colour options	

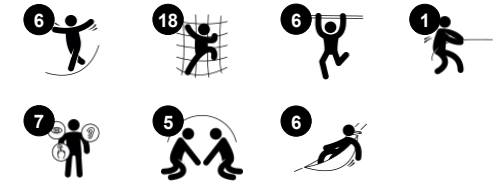

Adara II, with its spacious nets and swaying, bouncy play destinations attract and cater for heaps of playful children meeting and socializing. The rope, play shell and climbing details support varied body positions, thus catering for a wide span of ability levels. The responsiveness of the activities are fundamental motivation factors for play. The

interconnectedness of the nets and play shells means that the childrens' movements are felt throughout the net activities. At the ends, bouncy or swaying play items invite smaller group meetings. The intense physical feedback of the Adara II supports physical and social interaction for big groups. This supports the teenagers' wish for being with all their friends.

The climbing and bouncing in Adara II train their balance, proprioception and spatial awareness intensely. All skills needed for self confidence in moving.

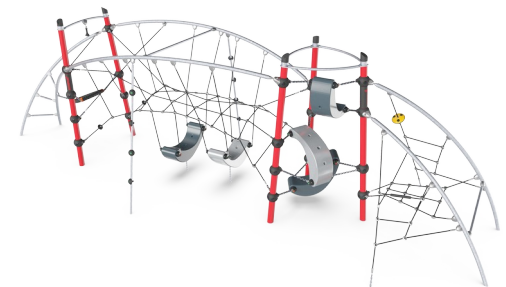

# Adara II

GXY950



## Twisted ladder

**Physical:** agility, balance and coordination. Muscle strength when swinging up for gripping handle. **Social-Emotional:** resting point, turn-taking and socializing.

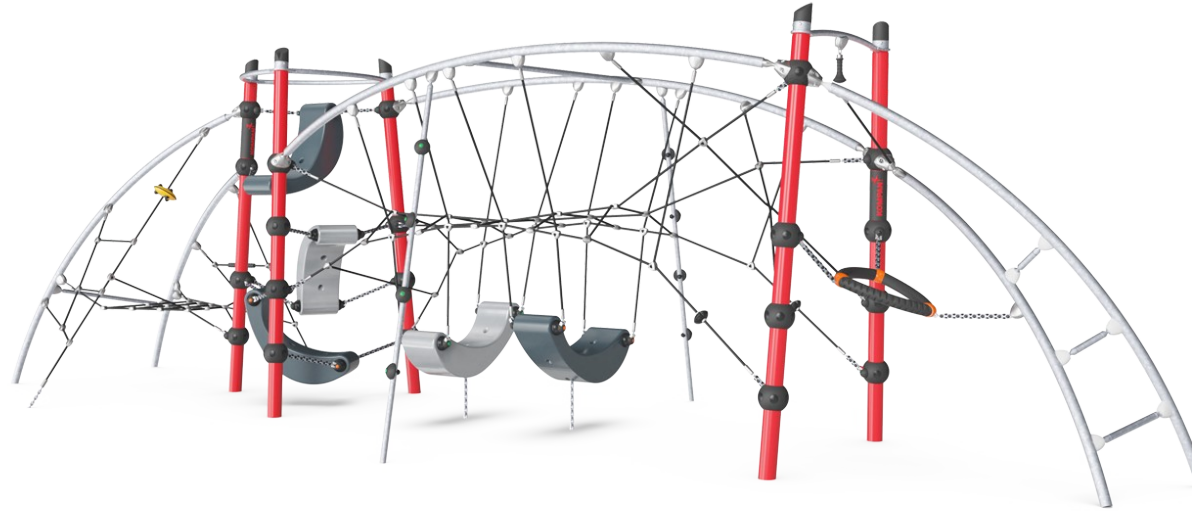

## Play shell

**Physical:** the swaying movement stimulates the sense of balance, necessary to sit still on a chair. **Social-Emotional:** meeting, taking a break and turn-taking are supported, skills necessary to learn how to avoid conflicts.



## Catena link

**Physical:** bouncy crawling and climbing supports cross coordination, balance and spatial awareness. **Social-Emotional:** spaciousness and interconnectedness of activities helps meeting in big groups. This is a teenage favorite and re-affirms them in their sense of belonging.



## Open triangle plate

**Physical:** arm, leg and core muscles are developed when climbing up/through. Proprioception and spatial awareness are also supported, both motor skills that help navigating the body in space. **Social-Emotional:** swaying, bouncy seat for a break, inviting socializing and turn-taking.



## Net

**Physical:** cross coordination when climbing or crawling in the net. This supports the cooperation of left and right brain half, important for other skills such as reading. **Social-Emotional:** taking a break together in the net and waiting for others to cross supports social abilities such as cooperation and communication.



## Play shell climber

**Physical:** swaying response to movement makes for challenging climbs and nice seating. **Social-Emotional:** socializing in smaller groups and turn-taking when deciding who should sit here.

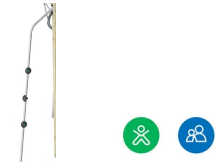

## Climbing pole

**Physical:** develops children's cross coordination, eye-hand coordination and muscle strength when climbing up or down. **Social-Emotional:** turn-taking and self-regulation are trained, both important life skills.

# Adara II

GXY950



The steel surfaces are hot dip galvanised inside and outside with lead free zinc. The galvanisation has excellent corrosion resistance in outside environments and requires low maintenance.



Hollow plastic components are made of 100% recyclable PE made from 33% post-consumer materials. The play shell displayed is molded in one piece with minimum 5mm wall thickness to ensure high durability in all climates around the world.



GALAXY climbing triangle with outer soft layer of PUR and corner brackets of moulded nylon (PA6). The core consist of a powder coated welded steel frame with integrated corner suspension points. Larger triangles are closed with an 18mm thick Ekogrip® panel that has a top-layer of rubber with a non-skid effect.



GALAXY ropes has six-stranded steel wires and a steel wire core. Each strand is tightly wrapped with PES yarn, which is melted onto each individual strand. The PES yarn is made of +95% Post-consumer materials to obtain excellent wear and tear resistance.



The unique designed GALAXY connection ball is made with an inner circular core of aluminium surrounded by a shell of hard PP with a outer layer of soft TPV rubber. Flexible lead free aluminium connectors allow for installation in variable angles.



Galaxy products are available in different colour combinations with either hot dip galvanised steel surface treatment or optional with powder top finish of selected steel components. Colours of the activities are adjusted to support the individual colour combination.

Item no. GXY950032-3717

### Installation Information

Max. fall height	249 cm
Safety surfacing area	62.2 m <sup>2</sup>
Total installation time	22.5
Excavation volume	5.30 m <sup>3</sup>
Concrete volume	1.92 m <sup>3</sup>
Footing depth (standard)	90 cm
Shipment weight	786 kg
Anchoring options	In-ground ✓ Surface ✓

### Warranty Information

Galaxy connection ball	5 years
Hot dip galvanised steel	Lifetime
PUR components	10 years
Ropes & nets	10 years
Spare parts guaranteed	10 years



# Sustainability Data

GXY950

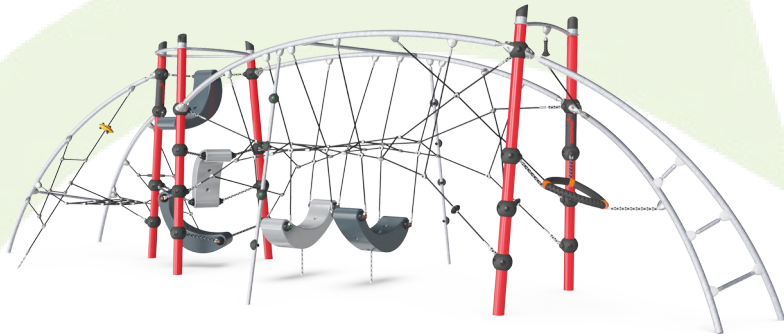

Cradle to Gate A1-A3	Total CO <sub>2</sub> emission	CO <sub>2</sub> e/kg	Recycled materials
	kg CO <sub>2</sub> e	kg CO <sub>2</sub> e/kg	%
<b>GXY950032-3717</b>	2,176.80	3.53	37.40

The overall framework applied for these factors is the Environmental Product Declaration (EPD), which quantifies "environmental information on the life cycle of a product and enable comparisons between products fulfilling the same function" (ISO, 2006). This follows the structure and applies a Life-Cycle Assessment approach to the entire Product stage from raw material through manufacturing (A1-A3))

**Kompan A/S**  
 C.F. Tietgens Boulevard 32C  
 DK-5220 Odense SØ  
 Denmark



## Verification of CO<sub>2</sub> calculation of: Challengers & Climbers

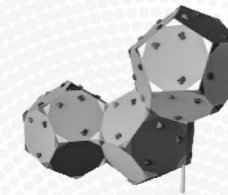

Data version no. 2023-10-05

The CO<sub>2</sub> calculation and data are in compliance with the principles of a carbon footprint impact according to the GHG protocol (Greenhouse Gas Protocol), Scope 3, cradle to gate related to all individual components in the product category: "Challengers & Climbers" represented by item no.: BLX410301-3717.

(Scope 3 emissions include emission sources in the upstream and downstream value chain).

**Date: 30. October 2023 | Valid until: 30. October 2025**

Verified by:

Julie Marie Vejsgaard Larsen, LCA & EPD Consultant

Verification based on report: Validation of CO<sub>2</sub> calculation of 9 categories of Kompan product line, version 1.0, prepared by: Bureau Veritas HSE, Denmark: Julie M. V. Larsen.

**Publication date: 30. October 2023**

By Bureau Veritas HSE  
 www.bureauveritas.dk  
 +45 7731 1000





# Adara II

GXY950

\* Max fall height | \*\* Total height | \*\*\* Safety surfacing area

\* Max fall height | \*\* Total height

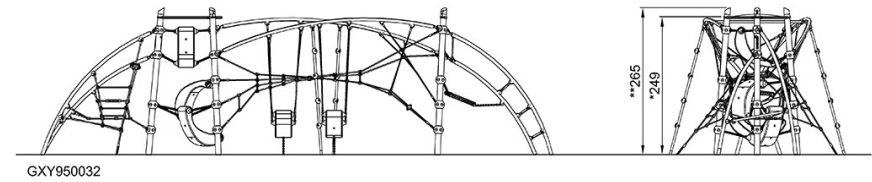
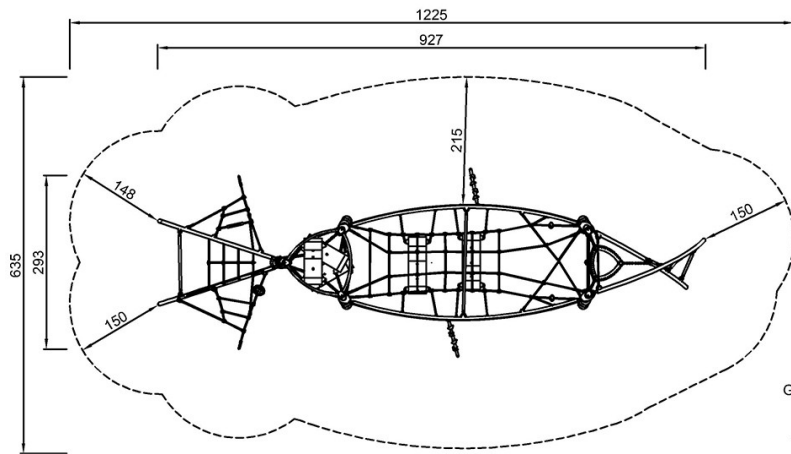

[Click to see TOP VIEW](#)

[Click to see SIDE VIEW](#)