

Carousel with Bars

KPL115

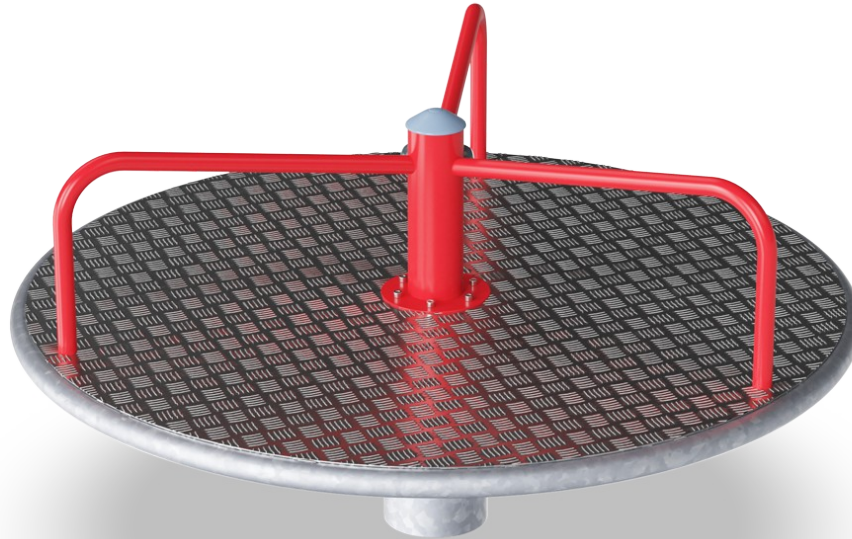

Item no. KPL115-0501

General Product Information

Dimensions LxWxH	155x155x81 cm
Age group	4+
Play capacity (users)	10
Colour options	

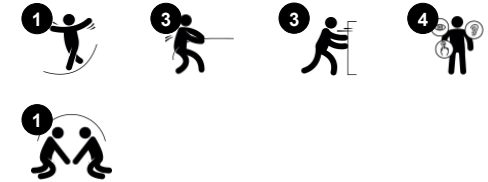

The red, spinning carousel attracts children and adults alike. With its seating platform height and three handholds many body positions are supported, making this a play champion again and again. The choice of body positions also supports users with various physical disabilities. Pushing or pulling the carousel into motion from the outside, children

take turns spinning or being spun. Pushing and pulling trains leg and arm muscles as well as condition. Spinning, apart from being a stomach tickling joy, trains the vestibular system and the whole sense of balance. This is fundamental for the child's ability to move around the world safely. It's fundamental for walking, running and even being able to sit still

and concentrate. With a under-developed sense of balance, children can focus on nothing but keeping equilibrium, even when seated. So the fun of carousel spinning serves a true purpose.

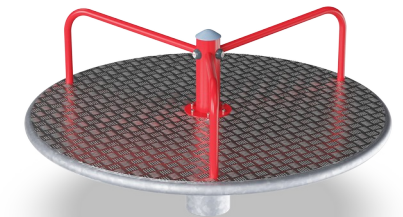

Carousel with Bars

KPL115

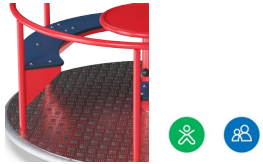

Handrails and side poles

Physical: pushing or pulling the carousel strengthens arm and leg muscles. **Social-Emotional:** pushing and pulling others facilitates cooperation and empathy: when to stop, how to take turns etc.

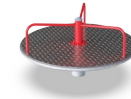
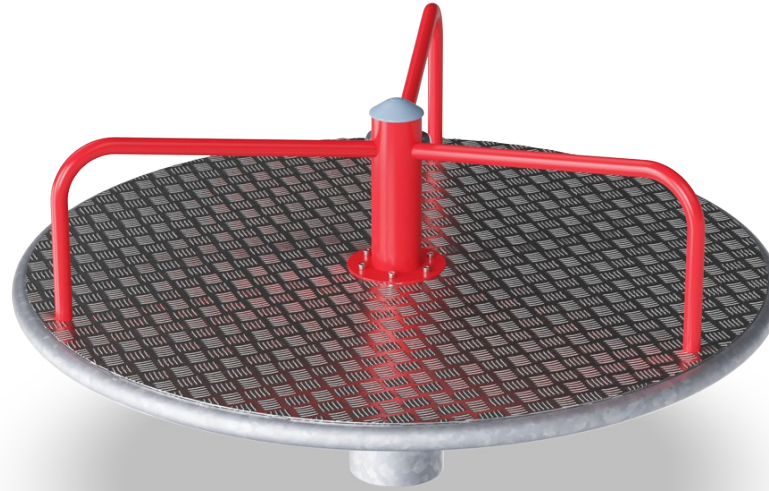

Rotation

Physical: pushing or pulling it into motion, children use their muscle strength and strengthen their cardio. The rotation develops the sense of balance and space when enjoying the ride. **Social-Emotional:** listening and negotiating how slow or fast to go, children develop their empathy and cooperation skills.

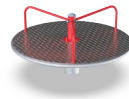

Flat platform

Physical: enables varied body positions e.g. lying, sitting, standing when spinning. **Social-Emotional:** spaciousness invites bigger groups of children playing together.

Carousel with Bars

KPL115

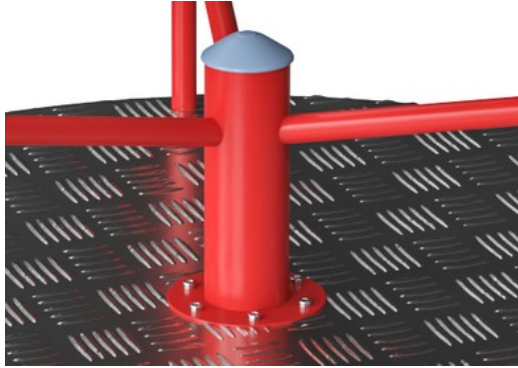

The steel surfaces are hot dip galvanised inside and outside with lead free zinc and with powder coated top-finish. The galvanisation has excellent corrosion resistance in outside environments and requires low maintenance.

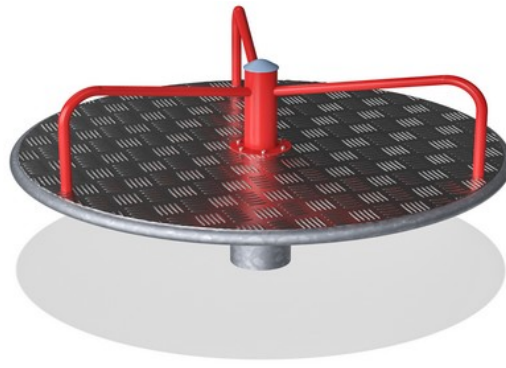

Heavy duty engineered bearing system with two single row deep groove high quality ball bearings with rubber seals. The fully closed bearing construction is lifetime lubricated and located above ground.

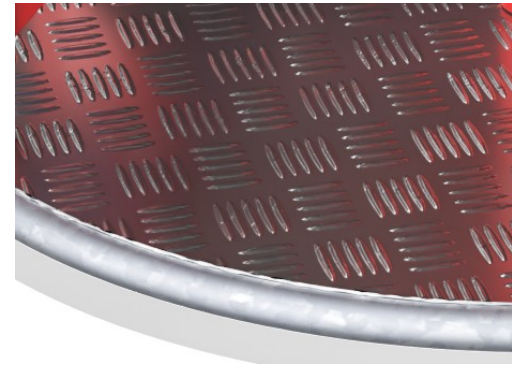

Deck plate of 3mm thick high-quality aluminium with 2mm texture pattern. This aluminium plate ensures safe play for all users and requires low maintenance.

Item no. KPL115-0501	
Installation Information	
Max. fall height	100 cm
Safety surfacing area	24.2 m ²
Total installation time	2.4
Excavation volume	0.45 m ³
Concrete volume	0.40 m ³
Footing depth (standard)	80 cm
Shipment weight	148 kg
Anchoring options	In-ground ✓
Warranty Information	
Aluminium deck	15 years
Bearing construction	5 years
Hot dip galvanised steel	Lifetime
Spare parts guaranteed	10 years



Sustainability Data

KPL115

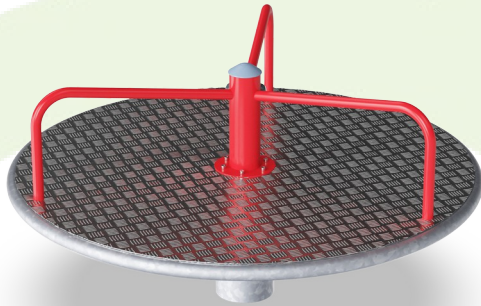

Cradle to Gate A1-A3	Total CO ₂ emission	CO ₂ e/kg	Recycled materials
	kg CO ₂ e	kg CO ₂ e/kg	%
KPL115-0501	421.11	3.52	43.94

The overall framework applied for these factors is the Environmental Product Declaration (EPD), which quantifies "environmental information on the life cycle of a product and enable comparisons between products fulfilling the same function" (ISO, 2006). This follows the structure and applies a Life-Cycle Assessment approach to the entire Product stage from raw material through manufacturing (A1-A3))

Kompan A/S
C.F. Tietgens Boulevard 32C
DK-5220 Odense SØ
Denmark



Verification of CO₂ calculation of: Freestanding play equipment



Data version no. 2023-10-05

The CO₂ calculation and data are in compliance with the principles of a carbon footprint impact according to the GHG protocol (Greenhouse Gas Protocol), Scope 3, cradle to gate related to all individual components in the product category: "Freestanding play equipment" represented by item no.: GXY916012-3417.

(Scope 3 emissions include emission sources in the upstream and downstream value chain).

Date: 30. October 2023 | Valid until: 30. October 2025

Verified by:

Julie Marie Vejsgaard Larsen, LCA & EPD Consultant

Verification based on report: Validation of CO₂ calculation of 9 categories of Kompan product line, version 1.0, prepared by: Bureau Veritas HSE, Denmark: Julie M. V. Larsen.

Publication date: 30. October 2023

By Bureau Veritas HSE
www.bureauveritas.dk
+45 7731 1000



Carousel with Bars

KPL115

* Max fall height | ** Total height | *** Safety surfacing area

* Max fall height | ** Total height

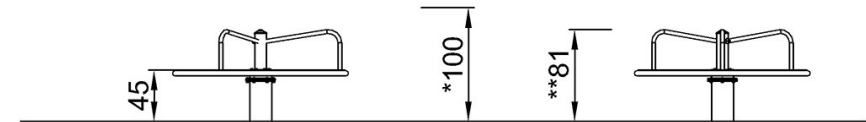
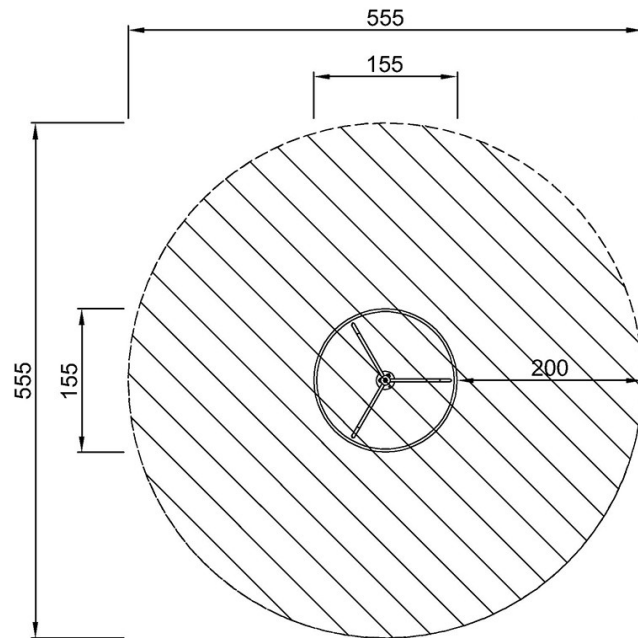

KPL115

KPL115
*100cm
**81cm
***24.2m²

[Click to see TOP VIEW](#)

[Click to see SIDE VIEW](#)