

FunPoint, Creator

PCT801

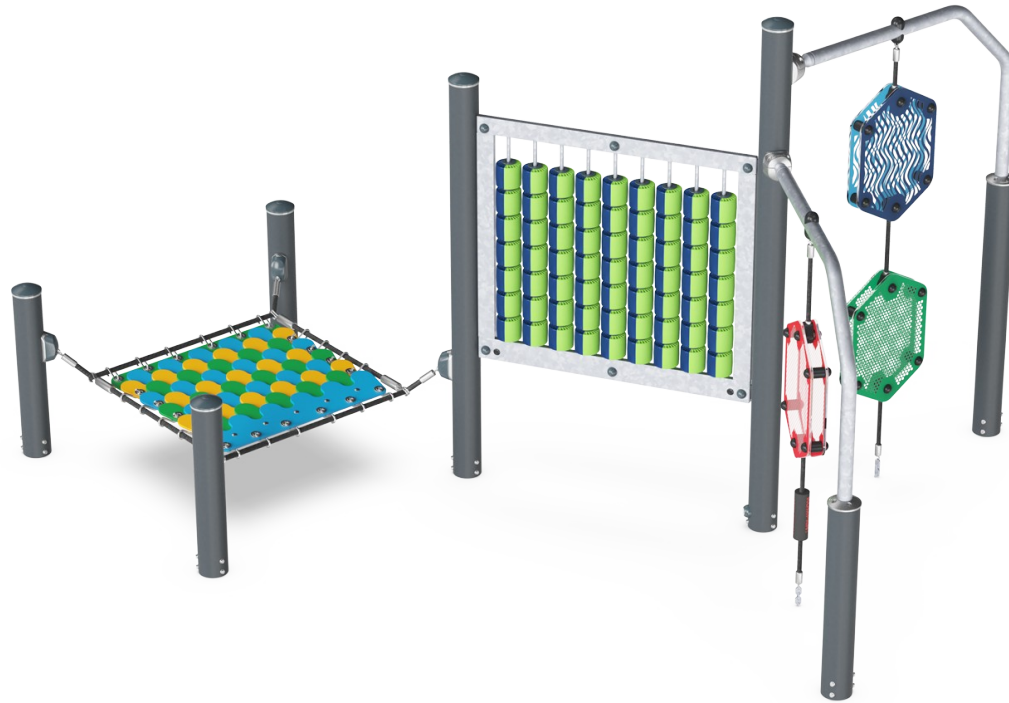

Item no. PCT801-0901	
General Product Information	
Dimensions LxWxH	199x321x185 cm
Age group	6+
Play capacity (users)	8
Colour options	



The dense play invitation of the FunPoint, Creator attracts children again and again. The meeting point character is evident, with the dragon scale membrane offering a fun seat with flaps. The drawing wall offers a repeated creative play experience, which encourages children to draw letters and patterns with the two-coloured rollers, which leaves tactile

physical marks on the playground. The three moirée effect panels intrigue children, as their patterns change when you gaze with focus on seeing more prominent patterns. This makes children ask "How?" and try to explain the workings of patterns and the visual effect making. This is a cognitively, stimulating process that trains children's logical thinking

and argumentation skills.



FunPoint, Creator

PCT801



Dichroic panels

Physical: hanging and leaning on the rope-suspended panels train muscles, balance and cross-coordination. **Social-Emotional:** twisting the panels to create colorful shadows encourage turn-taking and cooperation skills. **Cognitive:** wondering about, understanding and explaining the reasons for the color occurrence support logical thinking skills.

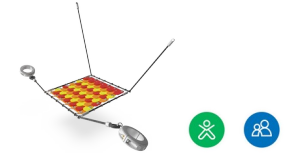
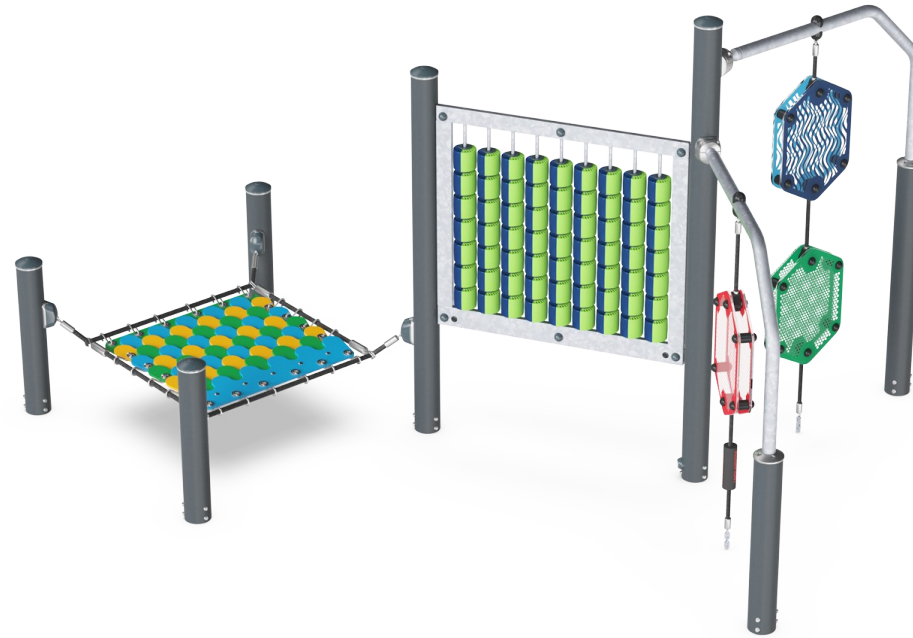

Dragon scale

Physical: the rubber scales add a fun feel to the seat and stimulates the sense of touch. **Social-Emotional:** great point for a break or meeting with friends.



Drawing wall

Physical: stimulate fine motor skills and add sensory stimulation when leaning on them. This soothes or invigorates depending on intensity. **Social-Emotional:** the cooperation and turn-taking in making patterns from both sides supports social-emotional skills such as cooperation. **Creative:** the two-colored rollers can be used from both sides, inspiring signal-making and creativity.

FunPoint, Creator

PCT801



Turnable optic panels of two 7mm thick polycarbonate plates with a distance of 40mm. The inside graphic print consist of an inner image layer and outer transparent protection layer. Both PC panel and the water-based lacquer are UV stabilized to prevent fading of the print.



The two colored turnable rollers are made of high quality UV stabilized and reinforced nylon (PA). The rollers are assembled on vertical steel pipes in a welded frame. All steel parts are hot dip galvanized.

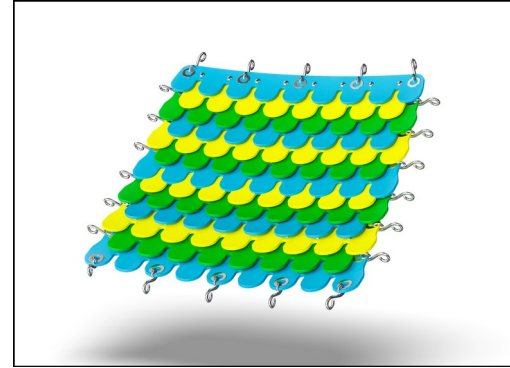

Colourful "Dragon Scale" made of friction-proof rubberized membrane of conveyor belt quality with excellent UV resistance. Embedded are two layers of galvanized steel wire armoring, making the membrane extremely durable.



Powder coated post are made of high quality pre galvanized steel with powder coated top finish. Post tops are closed with caps of UV stabilized nylon (PA6).

Item no. PCT801-0901	
Installation Information	
Max. fall height	33 cm
Safety surfacing area	24.8 m ²
Total installation time	7.9
Excavation volume	0.35 m ³
Concrete volume	0.05 m ³
Footing depth (standard)	90 cm
Shipment weight	221 kg
Anchoring options	In-ground ✓ Surface ✓
Warranty Information	
EcoCore HDPE	Lifetime
Galvanised/painted metal	10 years
Membrane	2 years
Polycarbonate PC panels	10 years
Spare Parts Guarantee	10 years



Sustainability Data

PCT801

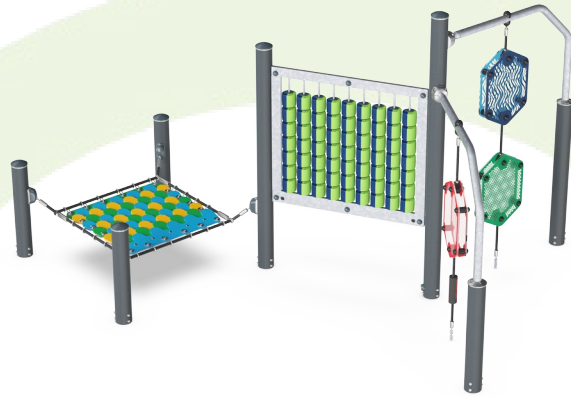

Cradle to Gate A1-A3	Total CO ₂ emission	CO ₂ e/kg	Recycled materials
	kg CO ₂ e	kg CO ₂ e/kg	%
PCT801-0901	664.03	4.19	40.22

The overall framework applied for these factors is the Environmental Product Declaration (EPD), which quantifies "environmental information on the life cycle of a product and enable comparisons between products fulfilling the same function" (ISO, 2006). This follows the structure and applies a Life-Cycle Assessment approach to the entire Product stage from raw material through manufacturing (A1-A3))

Kompan A/S
 C.F. Tietgens Boulevard 32C
 DK-5220 Odense SØ
 Denmark



Verification of CO₂ calculation of: Play systems



Data version no. 2023-10-05

The CO₂ calculation and data are in compliance with the principles of a carbon footprint impact according to the GHG protocol (Greenhouse Gas Protocol), Scope 3, cradle to gate related to all individual components in the product category: "Play systems" represented by item no.: PCM200321-0950.

(Scope 3 emissions include emission sources in the upstream and downstream value chain).

Date: 30. October 2023 | Valid until: 30. October 2025

Verified by:

Julie Marie Vejsgaard Larsen, LCA & EPD Consultant

Verification based on report: Validation of CO₂ calculation of 9 categories of Kompan product line, version 1.0, prepared by: Bureau Veritas HSE, Denmark: Julie M. V. Larsen.

Publication date: 30. October 2023

By Bureau Veritas HSE
 www.bureauveritas.dk
 +45 7731 1000



FunPoint, Creator

PCT801

* Max fall height | ** Total height | *** Safety surfacing area

* Max fall height | ** Total height

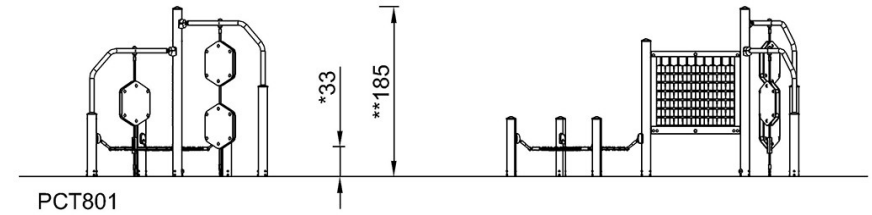
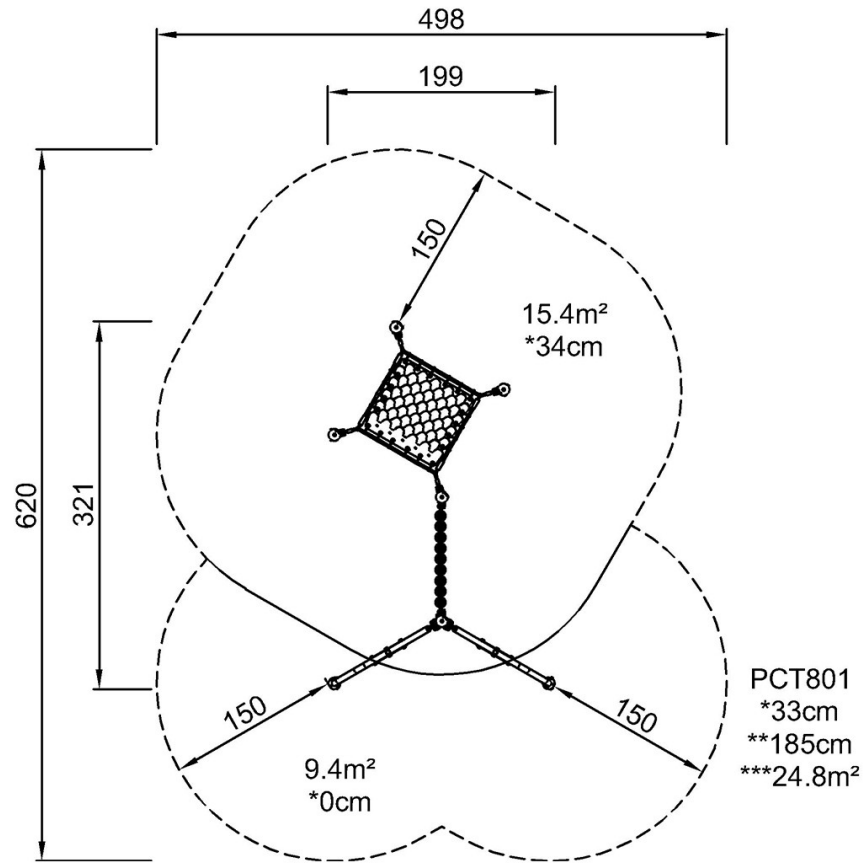

[Click to see TOP VIEW](#)

[Click to see SIDE VIEW](#)