

# Medite with House Membrane

COR10511

**KOMPAN**  
Let's play

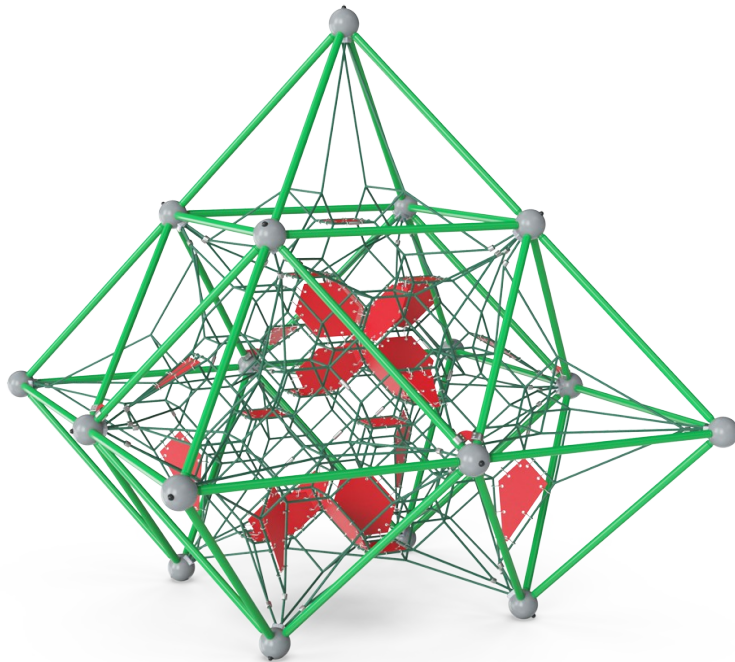

Item no. COR105111-0403

## General Product Information

Dimensions LxWxH	423x423x446 cm
Age group	5+
Play capacity (users)	31
Colour options	

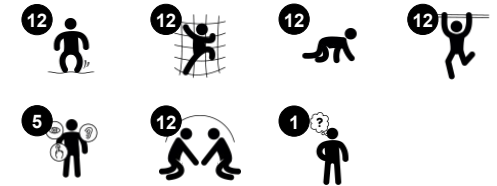

The Medite with House Membrane offers a wild climbing experience in three-dimensional nets. The meandering, bouncy climbing paths appeal immensely to children. The thrilling heights and transparency of action attract children again and again and make them want to come back. Membranes add fast, bouncy routes to the top and function as destinations and meeting

points. Social interaction and stimulation of cooperation is encouraged here. The bouncy ropes and nets of the Medite add thrill: the child can feel its own and all their friends movements when using the net. At this height that means risk assessment and concentration. The nets train important motor skills such as proprioception, spatial awareness and cross-

body coordination. These skills are fundamental for risk assessment when for instance judging and navigating traffic securely.

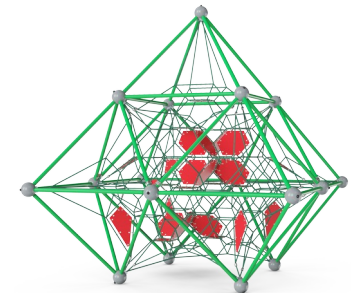

# Medite with House Membrane

COR10511

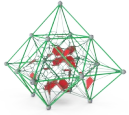

## Height

**Social-Emotional:** children develop courage and self-regulation when being up high. This positively affects self-confidence.

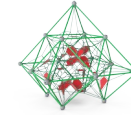
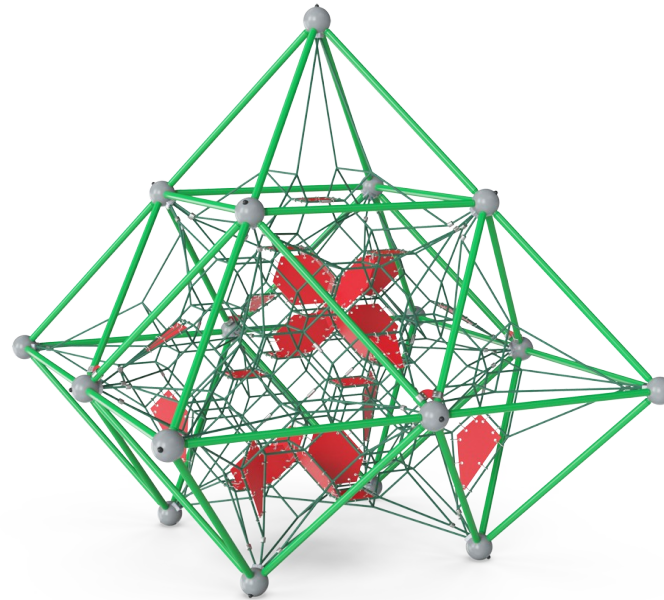

## Big meshes

**Physical:** the big meshes allow for climbing and crawling, supporting proprioception, cross coordination and spatial awareness. Climbing here takes muscle strength, pushing and pulling arms to get upwards. **Social-Emotional:** allow more children being seated together, sharing.

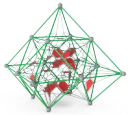

## Connected nets

**Physical:** the connected nets make the climbers feel the movements of the others, adding a dimension of fun and demanding concentration when holding tight to the rope. Cross-coordination and all muscle groups are trained. **Social-Emotional:** the climbers' movements affect the other climbers, so consideration and turn-taking is supported.

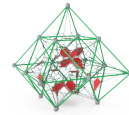

## Membrane path

**Physical:** a faster way up, due to the extra support of the membrane. **Social-Emotional:** a meeting path with points for retreat from the rope landscape.

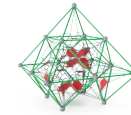

## Transparency

**Social-Emotional:** the transparency makes possible cooperation and communication throughout, all important life-skills for children to learn.

# Medite with House Membrane

COR10511



Corocord 'S' clamps are used as universal connections in Corocord products. 8mm stainless steel rods with rounded edges are pressed around the ropes with a special hydraulic press, making them the ideal connector: safe, durable and vandalism-proof, all while allowing the typical movement of rope climbing structures.

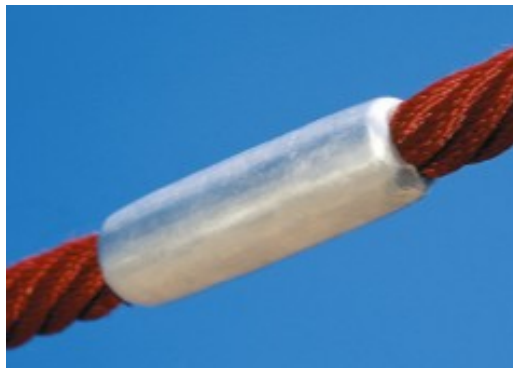

The aluminium swages of the net are double conical with rounded ends and are as small as safety allows. The overall net design aims at keeping metal parts within the net to an absolute minimum, both in size and number, in order to provide the best possible rope climbing experience.

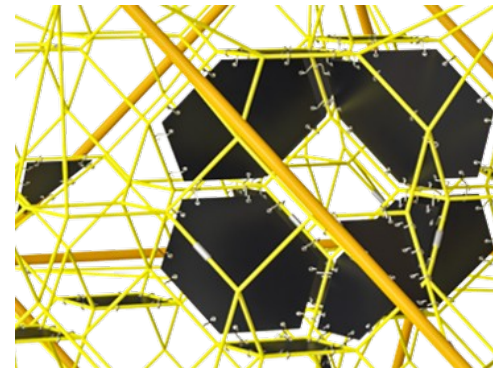

Corocord membranes consist of friction-proof rubberized material of conveyor belt quality with excellent UV resistance. Tested and compliant with REACH requirements for PAH. Embedded is a four-layered armouring made of woven polyester. The armouring and the two surface layers result in a total thickness of 7.5 mm.

Item no. COR105111-0403	
Installation Information	
Max. fall height	165 cm
Safety surfacing area	51.7 m <sup>2</sup>
Total installation time	29.6
Excavation volume	1.76 m <sup>3</sup>
Concrete volume	0.98 m <sup>3</sup>
Footing depth (standard)	110 cm
Shipment weight	1,029 kg
Anchoring options	In-ground ✓
Warranty Information	
Corocord rope	10 years
EcoCore HDPE	Lifetime
Hot dip galvanised steel	Lifetime
Membrane	2 years
Spare parts guaranteed	10 years



The metal parts are made of high quality steel, hot dip galvanised inside and outside with leadfree zinc. On the outside, there is an additional layer of powder coating. This ensures both excellent corrosion resistance and colourful design expression.

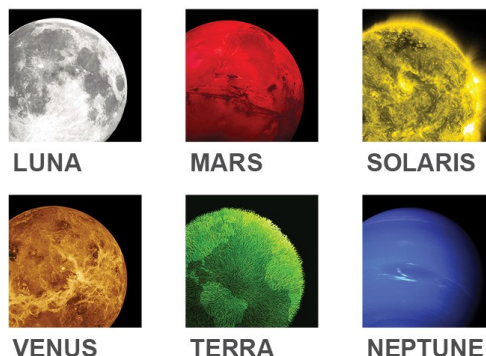

The COROCORD Frame Nets are available in 6 galactic colour themes. The themes draw on bright colours that appeal to children of all ages. Can be changed in the configurator.



# Sustainability Data

COR10511

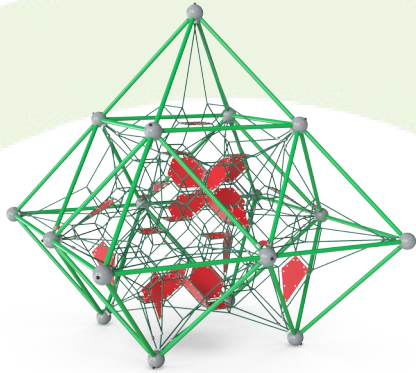

Cradle to Gate A1-A3	Total CO <sub>2</sub> emission	CO <sub>2</sub> e/kg	Recycled materials
	kg CO <sub>2</sub> e	kg CO <sub>2</sub> e/kg	%
<b>COR105111-0403</b>	2,715.66	3.80	42.33

The overall framework applied for these factors is the Environmental Product Declaration (EPD), which quantifies "environmental information on the life cycle of a product and enable comparisons between products fulfilling the same function" (ISO, 2006). This follows the structure and applies a Life-Cycle Assessment approach to the entire Product stage from raw material through manufacturing (A1-A3))

**Kompan A/S**  
 C.F. Tietgens Boulevard 32C  
 DK-5220 Odense SØ  
 Denmark



## Verification of CO<sub>2</sub> calculation of: Corocord



Data version no. 2023-10-05

The CO<sub>2</sub> calculation and data are in compliance with the principles of a carbon footprint impact according to the GHG protocol (Greenhouse Gas Protocol), Scope 3, cradle to gate related to all individual components in the product category: "Corocord" represented by item no.: COR314011-1101.

(Scope 3 emissions include emission sources in the upstream and downstream value chain).

**Date: 30. October 2023 | Valid until: 30. October 2025**

Verified by:

Julie Marie Vejsgaard Larsen, LCA & EPD Consultant

Verification based on report: Validation of CO<sub>2</sub> calculation of 9 categories of Kompan product line, version 1.0, prepared by: Bureau Veritas HSE, Denmark: Julie M. V. Larsen.

**Publication date: 30. October 2023**

By Bureau Veritas HSE  
 www.bureauveritas.dk  
 +45 7731 1000



# Medite with House Membrane

COR10511

\* Max fall height | \*\* Total height | \*\*\* Safety surfacing area

\* Max fall height | \*\* Total height

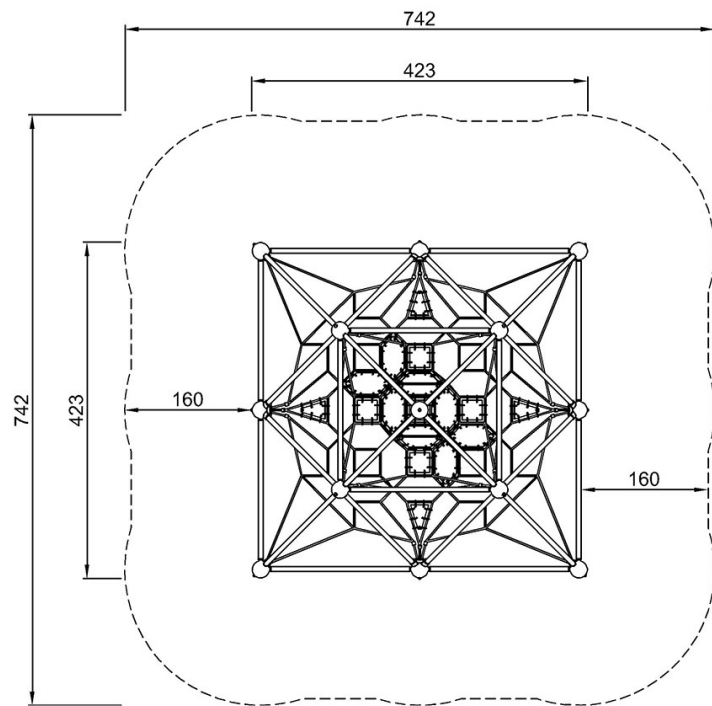

COR10511  
\*165cm  
\*\*446cm  
\*\*\*51.7m<sup>2</sup>

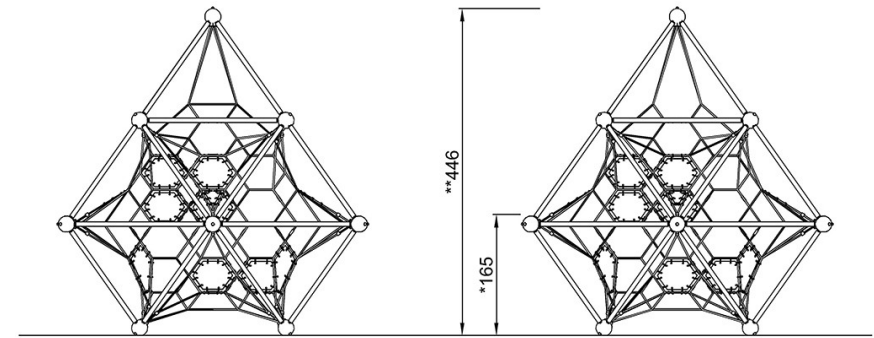

COR10511

[Click to see TOP VIEW](#)

[Click to see SIDE VIEW](#)