

Giant Rope Play Tower

COR29700

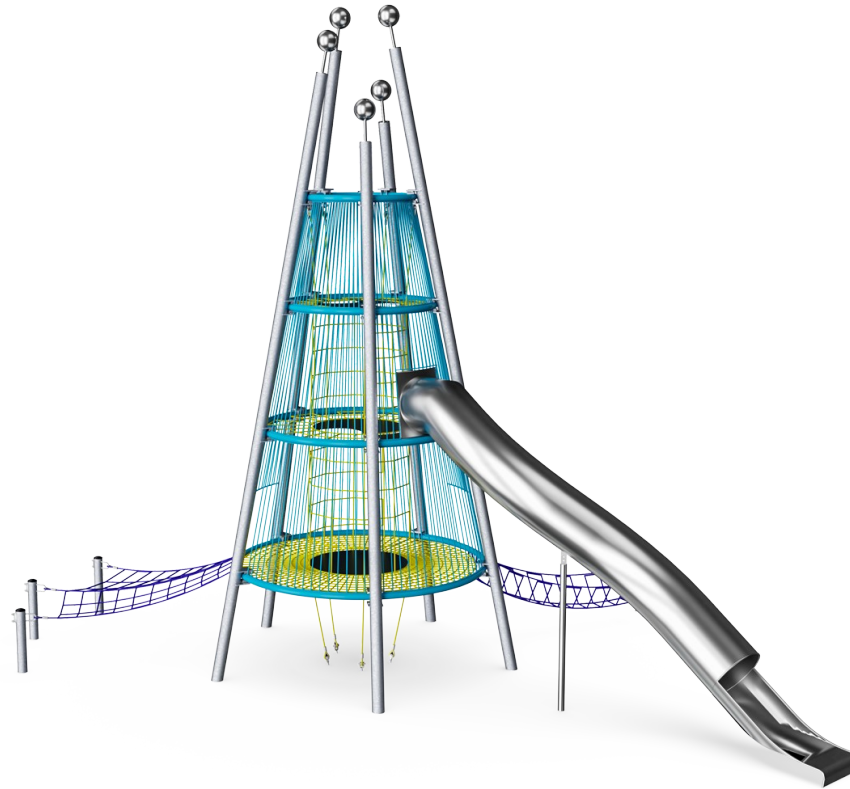

| | |
|------------------------------------|-----------------|
| Item no. COR297001-1202 | |
| General Product Information | |
| Dimensions LxWxH | 1050x811x915 cm |
| Age group | 5+ |
| Play capacity (users) | 65 |
| Colour options | |

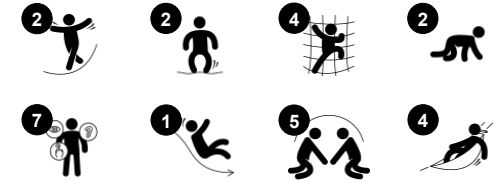

The Giant Rope Play Tower takes play to new heights. The children will explore the unit wanting to go up high and whizz down the slide as fast as they can. A swaying climb up to the first platform of the play tower calls for a break. The bouncy membrane allows children to bounce developing their balance skills. The next platform offers a thrilling slide down. Apart

from being great fun, this trains children's sense of balance, important for instance for sitting still on a chair. The next level is exhilarating: a view from 9 meters high. Apart from the awe of this, it trains the child's spatial awareness, which again is important for instance for judging distances in the street. The Giant Rope Play Tower is so much more than

mere thrill, it helps challenge and develop children's physical and social skills.

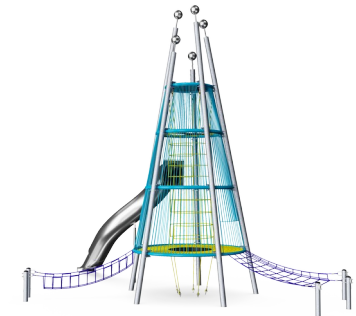

Giant Rope Play Tower

COR29700



Height

Social-Emotional: children develop courage and self-regulation when being up high. This positively affects self-confidence.

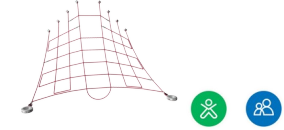
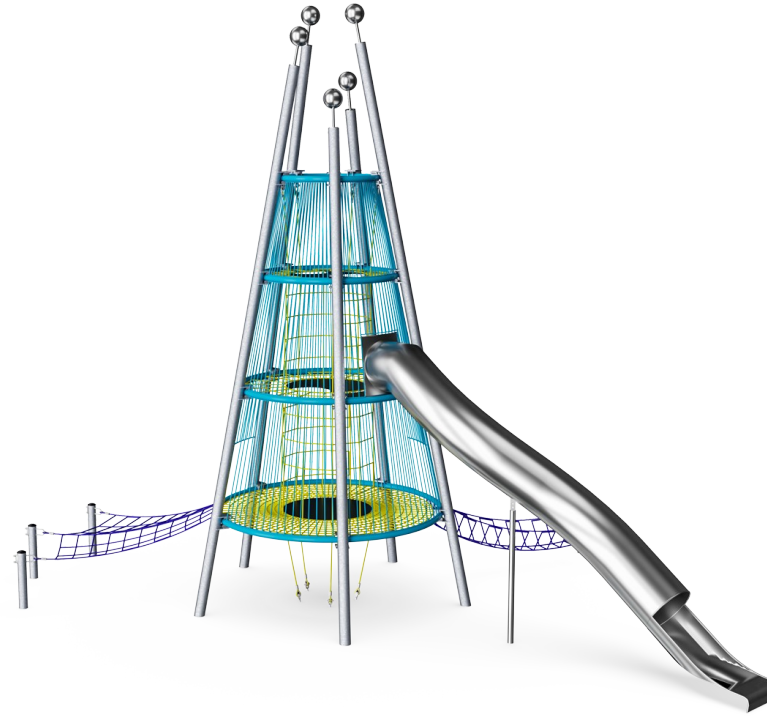

Inclined net

Physical: the inclined net supports the upward climbing movement of the body, training cross-body coordination and muscle strength. **Social-Emotional:** the meshes allow for more children being seated or lying together, sharing.



Tube slide

Physical: develops spatial awareness, sense of balance and trains core muscles when sitting upright going down. **Social-Emotional:** thrill when going down fast. Empathy stimulated by turn-taking.

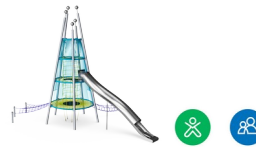

Internal climbing net

Physical: children develop cross-body coordination and muscle strength. The big meshes allow trains proprioception and spatial awareness. **Social-Emotional:** the big meshes allow for more children being seated together, sharing.

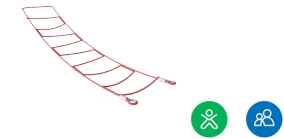

Waggle bridge

Physical: sense of balance and training of cross coordination. Important for other skills such as being able to sit still. **Social-Emotional:** turn-taking and helping others when climbing up.

Giant Rope Play Tower

COR29700



Corocord ropes with 19mm+ diameter are known as a 'Hercules' rope type which is formed from galvanised six-stranded steel wires. Each strand is tightly wrapped with PES yarn, which is melted onto each individual strand. Ropes are highly wear-and vandalism-resistant and can be easily replaced on-site if needed.



Designed to allow the typical function of rope play structures to move Corocord 'S' clamps are used as universal connections in Corocord products. 8mm stainless steel rods with rounded edges are pressed around the ropes with a special hydraulic press, making them the ideal connector. Our clamps are safe, durable and vandalism-proof.



The aluminium swages of the net are double conical with rounded ends and are as small as safety allows. The overall net design aims at keeping metal parts within the net to an absolute minimum, both in size and number, to provide the best possible rope climbing experience.



Corocord membranes consist of friction-proof rubberised material of conveyor belt quality with excellent UV resistance. Tested and compliant with REACH requirements for PAH. Embedded is a four-layered armoring made of woven polyester. The armoring and the two surface layers result in a total thickness of 7.5 mm.



The metal parts are made from high-quality steel consisting of hot-dip galvanisation on both the inside and outside and also includes lead-free zinc and an additional layer of powder coating. This ensures both excellent corrosion resistance and colourful design expression.

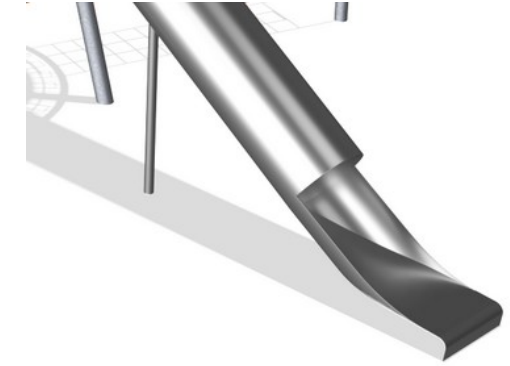

The stainless steel components are made of high-quality stainless steel in compliance with global playground standards. The steel is glass blasted after manufacturing to ensure a smooth gliding surface.

| Item no. COR297001-1202 | |
|--------------------------|----------------------|
| Installation Information | |
| Max. fall height | 150 cm |
| Safety surfacing area | 76.5 m ² |
| Total installation time | 103.0 |
| Excavation volume | 19.94 m ³ |
| Concrete volume | 13.90 m ³ |
| Footing depth (standard) | 120 cm |
| Shipment weight | 5,581 kg |
| Anchoring options | In-ground ✓ |
| Warranty Information | |
| Corocord (Hercules) Rope | 10 years |
| Galvanised Steel | Lifetime |
| Membrane | 2 years |
| S-Clamps | 10 years |
| Spare Parts Guarantee | 10 years |



Sustainability Data

COR29700

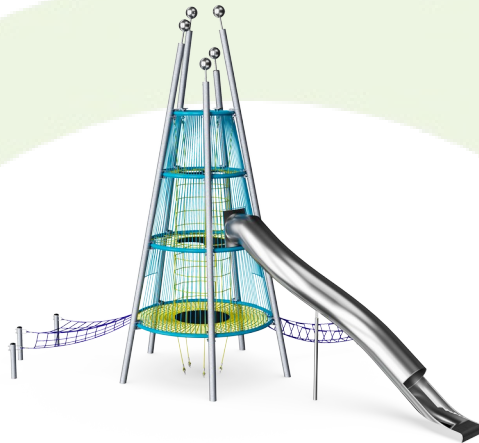

| Cradle to Gate A1-A3 | Total CO ₂ emission | CO ₂ e/kg | Recycled materials |
|-----------------------|--------------------------------|-------------------------|--------------------|
| | kg CO ₂ e | kg CO ₂ e/kg | % |
| COR297001-1202 | 11,171.33 | 2.78 | 51.24 |

The overall framework applied for these factors is the Environmental Product Declaration (EPD), which quantifies "environmental information on the life cycle of a product and enable comparisons between products fulfilling the same function" (ISO, 2006). This follows the structure and applies a Life-Cycle Assessment approach to the entire Product stage from raw material through manufacturing (A1-A3))

Kompan A/S
 C.F. Tietgens Boulevard 32C
 DK-5220 Odense SØ
 Denmark



Verification of CO₂ calculation of: Corocord



Data version no. 2023-10-05

The CO₂ calculation and data are in compliance with the principles of a carbon footprint impact according to the GHG protocol (Greenhouse Gas Protocol), Scope 3, cradle to gate related to all individual components in the product category: "Corocord" represented by item no.: COR314011-1101.

(Scope 3 emissions include emission sources in the upstream and downstream value chain).

Date: 30. October 2023 | Valid until: 30. October 2025

Verified by:

Julie Marie Vejsgaard Larsen, LCA & EPD Consultant

Verification based on report: Validation of CO₂ calculation of 9 categories of Kompan product line, version 1.0, prepared by: Bureau Veritas HSE, Denmark: Julie M. V. Larsen.

Publication date: 30. October 2023

By Bureau Veritas HSE
 www.bureauveritas.dk
 +45 7731 1000



Giant Rope Play Tower

COR29700

* Max fall height | ** Total height | *** Safety surfacing area

* Max fall height | ** Total height

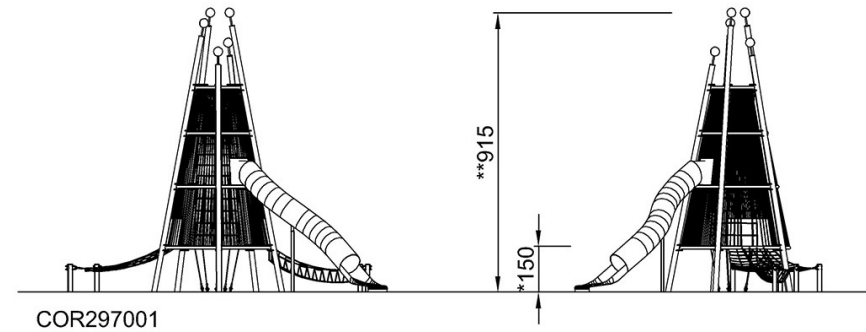
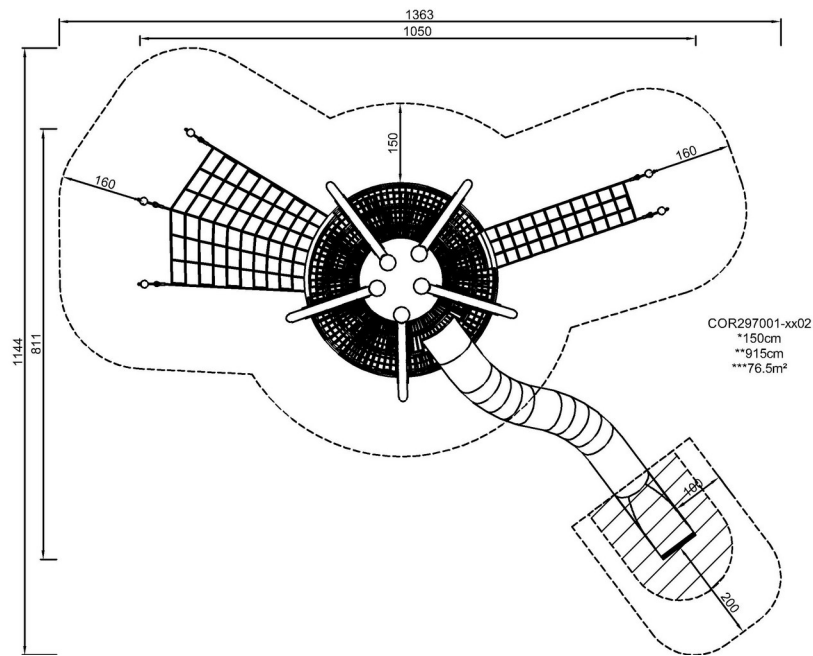

[Click to see TOP VIEW](#)

[Click to see SIDE VIEW](#)