

Embankment Tunnel Slide

COR71007

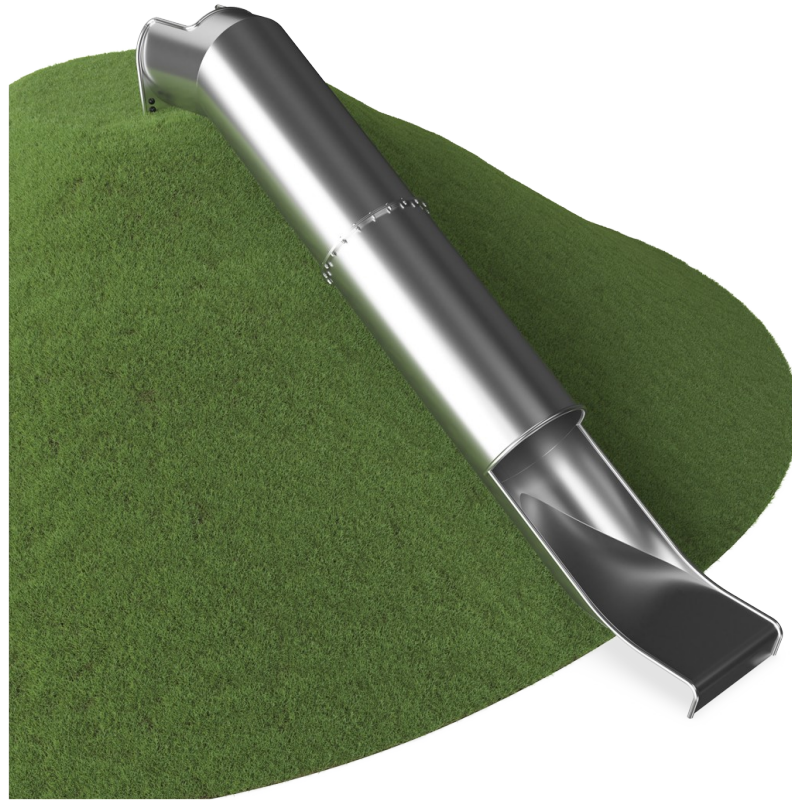

Item no. COR710071-0400	
General Product Information	
Dimensions LxWxH	510x84x79 cm
Age group	3+
Play capacity (users)	2
Colour options	●



The Embankment Tunnel Slide is extremely attractive. It makes children loop up hill and slide down again and again. The Embankment Tunnel Slide could be the main attraction in a playground. Apart from the immense thrill of sliding, the Embankment Tunnel Slide also give children support in developing important motor skills. Children train the sense of space and

balance. These are important when managing the world securely, avoiding falls and accidents. Gaining the courage to go down the steep tunnel adds a sweet sensation of achievement when sliding the Embankment Tunnel Slide. This is a social-emotional benefit, which is further enhanced by the cooperation and turn taking skills that children train when

entering. The width of the slide invites rides with friends. The slide mouth is extra long to add a feeling of security.



Embankment Tunnel Slide

COR71007



Tube slide

Physical: sliding develops spatial awareness and a sense of balance. Furthermore, the core muscles are trained when sitting upright going down. **Social-Emotional:** thrill when going down fast. Empathy stimulated by turn-taking. **Cognitive:** young children train their understanding of space, speed and distances when sliding down quickly.

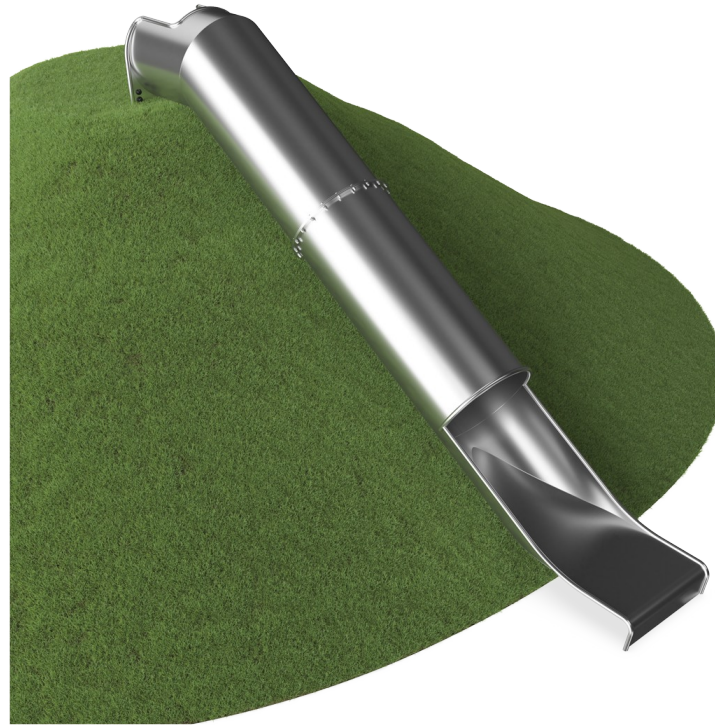

Embankment Tunnel Slide

COR71007



At 35°, the slide is set to the optimum angle to ensure both gliding fun and safety.



Catering to different terrains, the embankment slides are available in 9 lengths from 1 - 3m.

Item no. COR710071-0400

Installation Information

Max. fall height	100 cm
Safety surfacing area	15.0 m ²
Total installation time	7.0
Excavation volume	0.70 m ³
Concrete volume	0.36 m ³
Footing depth (standard)	100 cm
Shipment weight	370 kg
Anchoring options	In-ground ✓

Warranty Information

Spare parts guaranteed	10 years
Stainless steel slide	10 years



Sustainability Data

COR71007

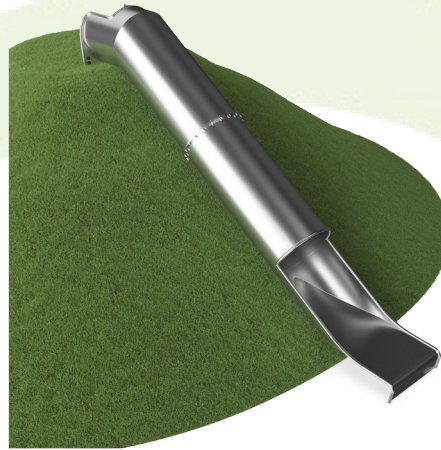

Cradle to Gate A1-A3	Total CO ₂ emission	CO ₂ e/kg	Recycled materials
	kg CO ₂ e	kg CO ₂ e/kg	%
COR710071-0400	1,552.79	4.19	49.98

The overall framework applied for these factors is the Environmental Product Declaration (EPD), which quantifies "environmental information on the life cycle of a product and enable comparisons between products fulfilling the same function" (ISO, 2006). This follows the structure and applies a Life-Cycle Assessment approach to the entire Product stage from raw material through manufacturing (A1-A3))

Kompan A/S
 C.F. Tietgens Boulevard 32C
 DK-5220 Odense SØ
 Denmark



Verification of CO₂ calculation of: Corocord



Data version no. 2023-10-05

The CO₂ calculation and data are in compliance with the principles of a carbon footprint impact according to the GHG protocol (Greenhouse Gas Protocol), Scope 3, cradle to gate related to all individual components in the product category: "Corocord" represented by item no.: COR314011-1101.

(Scope 3 emissions include emission sources in the upstream and downstream value chain).

Date: 30. October 2023 | Valid until: 30. October 2025

Verified by:

Julie Marie Vejsgaard Larsen, LCA & EPD Consultant

Verification based on report: Validation of CO₂ calculation of 9 categories of Kompan product line, version 1.0, prepared by: Bureau Veritas HSE, Denmark: Julie M. V. Larsen.

Publication date: 30. October 2023

By Bureau Veritas HSE
 www.bureauveritas.dk
 +45 7731 1000



Embankment Tunnel Slide

COR71007

* Max fall height | ** Total height | *** Safety surfacing area

* Max fall height | ** Total height

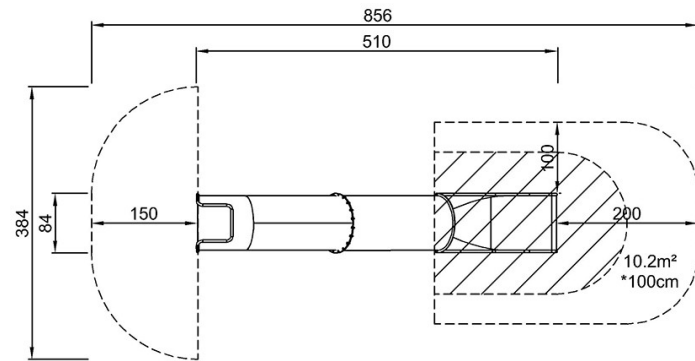

COR710071-0400
*100cm
**79cm
***15m²

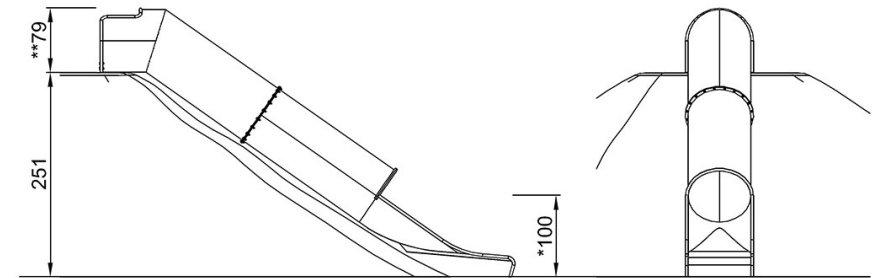

COR710071-0400

[Click to see TOP VIEW](#)

[Click to see SIDE VIEW](#)