

Agora Picnic Mini - Steel

PAR4180

KOMPAN
Let's play



Item no. PAR4180-0004

General Product Information

Dimensions LxWxH 105x134x60 cm

Age group

Play capacity (users) -

Colour options



Outdoor Furniture plays an essential role in our communities by adding an inviting and social atmosphere, a place to meet, socialise or rest. Inclusive Design As Standard. AGORA is designed to fulfil the UN Convention on the Rights of Persons with Disabilities (CRPD), which requires universal design principles when creating public spaces. Installing AGORA

furniture in a public area goes beyond satisfying all-inclusive design requirements. AGORA Picnic comes in two sizes and multiple material choices, but with one aim; an opportunity for adults or children to make that al fresco moment special. The Mini is designed with a seating height suited for children.



Agora Picnic Mini - Steel

PAR4180



The steel surfaces are hot dip galvanized inside and outside with lead free zinc. The galvanization has excellent corrosion resistance in outdoor environments and require low maintenance. Painted steel parts are hot dip galvanized before powder coating.



Powder coated top finish on top of galvanisation is processed in two steps: Light grinding and clean sweeping, powder coating - thickness 70-120 µm.



The Agora full steel assortment is available as standard in 9 different colors to match the selected color scheme on the play, sport or fitness site.

Item no. PAR4180-0004

Installation Information

Total installation time	2.8
Excavation volume	0.00 m ³
Concrete volume	0.00 m ³
Footing depth (standard)	0 cm
Shipment weight	117 kg
Anchoring options	Surface ✓ In-ground ✓

Warranty Information

Hot dip galvanized steel	Lifetime
Painted toplayer	10 years
Spare parts guaranteed	10 years
Stainless steel components	Lifetime



The furniture is a freestanding product with optional anchoring possibilities. Kompan has multiple anchoring's to fit specific requirements for individual customer projects. The anchoring is sold as separate modules.

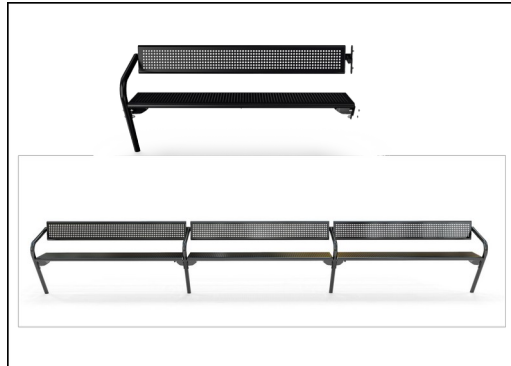

The standard available benches and tables can be dressed up with back support, armrests, tables etc. and linked together into tailored solutions for the individual location.



The hardware is made of stainless steel or galvanized steel to ensure durable connections with a high corrosion resistance.

Sustainability Data

PAR4180



Cradle to Gate A1-A3	Total CO ₂ emission	CO ₂ e/kg	Recycled materials
	kg CO ₂ e	kg CO ₂ e/kg	%
PAR4180-0004	216.29	2.58	50.00

The overall framework applied for these factors is the Environmental Product Declaration (EPD), which quantifies "environmental information on the life cycle of a product and enable comparisons between products fulfilling the same function" (ISO, 2006). This follows the structure and applies a Life-Cycle Assessment approach to the entire Product stage from raw material through manufacturing (A1-A3))

Kompan A/S
C.F. Tietgens Boulevard 32C
DK-5220 Odense SØ
Denmark



Verification of CO₂ calculation of: Park

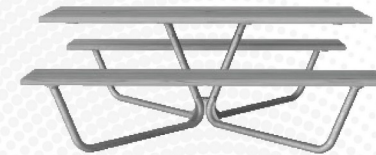

Data version no. 2023-10-05

The CO₂ calculation and data are in compliance with the principles of a carbon footprint impact according to the GHG protocol (Greenhouse Gas Protocol), Scope 3, cradle to gate related to all individual components in the product category: "Park" represented by item no.: PAR4070-0001.

(Scope 3 emissions include emission sources in the upstream and downstream value chain).

Date: 30. October 2023 | Valid until: 30. October 2025

Verified by:

Julie Marie Vejsgaard Larsen, LCA & EPD Consultant

Verification based on report: Validation of CO₂ calculation of 9 categories of Kompan product line, version 1.0, prepared by: Bureau Veritas HSE, Denmark: Julie M. V. Larsen.

Publication date: 30. October 2023

By Bureau Veritas HSE
www.bureauveritas.dk
+45 7731 1000

