

Oasis Sand Hut with Two Tables

NRO526

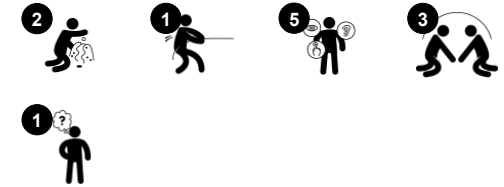

Item no. NRO526-1021	
General Product Information	
Dimensions LxWxH	180x195x248 cm
Age group	1+
Play capacity (users)	5
Colour options	



This Oasis sand hut with two tables is a great play motivator that will make many children absorbed in play again and again. It can be played from all sides and allows for interaction from the inside-out and vice versa. This makes it a universally designed unit that can be used by all ages and abilities. The two desks and the sand scoop are great for exchanging, or merely

for storing stuff or supporting sand play. The theme of the house will inspire dramatic play. Dramatic play is great language stimulation and develops children's cognitive skills. The social nature of the play house will accommodate bigger groups of children playing. The layout allows for eye contact throughout the unit, supporting communication

and cooperation, both fundamental for social-emotional development of children.



Oasis Sand Hut with Two Tables

NRO526



Sand shovel

Physical: develops dexterity and upper body muscles. **Cognitive:** understanding of object permanence, emptying and filling scoop.



Side desk

Social-Emotional: fine meeting place and a space creator. Sharing and cooperation from both sides create a social scenario that supports communication and cooperation.



Splash basin with plug

Social-Emotional: meeting point for cooperation and sharing. Develops turn-taking and cooperation. **Cognitive:** logical thinking and understanding of cause and effect are trained when children stop or let go of water from the basin. **Creative:** the water plug makes changing water levels possible, which adds to logical thinking skills.

Oasis Sand Hut with Two Tables

NRO526



All Organic Robinia products by KOMPAN are made of Robinia wood from sustainable European sources. On request it can be supplied as FSC® Certified (FSC® C004450).



The paint used for coloured components is water based environmentally friendly with excellent UV resistance. The paint is in compliance with EN 71 Part 3.



The Robinia products are designed with a KOMPAN colour concept with a number of different standard colours. The wood can also be supplied as untreated or with brown painted with a pigment that maintains the wood colour.



The product/activities are preassembled from the factory to ensure all safety requirements are considered.

Item no. NRO526-1021	
Installation Information	
Max. fall height	0 cm
Safety surfacing area	17.5 m ²
Total installation time	7.2
Excavation volume	0.45 m ³
Concrete volume	0.00 m ³
Footing depth (standard)	100 cm
Shipment weight	416 kg
Anchoring options	In-ground ✓
Warranty Information	
Robinia wood	15 years
Ropes & nets	10 years
Spare parts guaranteed	10 years
Stainless steel components	Lifetime
Stainless steel components	Lifetime



Sustainability Data

NRO526



Cradle to Gate A1-A3	Total CO ₂ emission	CO ₂ e/kg	Recycled materials
	kg CO ₂ e	kg CO ₂ e/kg	%
NRO526-1021	131.31	0.40	3.65

The overall framework applied for these factors is the Environmental Product Declaration (EPD), which quantifies "environmental information on the life cycle of a product and enable comparisons between products fulfilling the same function" (ISO, 2006). This follows the structure and applies a Life-Cycle Assessment approach to the entire Product stage from raw material through manufacturing (A1-A3))

Kompan A/S
 C.F. Tietgens Boulevard 32C
 DK-5220 Odense SØ
 Denmark



Verification of CO₂ calculation of: Nature play



Data version no. 2023-10-05

The CO₂ calculation and data are in compliance with the principles of a carbon footprint impact according to the GHG protocol (Greenhouse Gas Protocol), Scope 3, cradle to gate related to all individual components in the product category: "Nature play" represented by item no.: NRO409-0621.

(Scope 3 emissions include emission sources in the upstream and downstream value chain).

Date: 30. October 2023 | Valid until: 30. October 2025

Verified by:

Julie Marie Vejsgaard Larsen, LCA & EPD Consultant

Verification based on report: Validation of CO₂ calculation of 9 categories of Kompan product line, version 1.0, prepared by: Bureau Veritas HSE, Denmark: Julie M. V. Larsen.

Publication date: 30. October 2023

By Bureau Veritas HSE
 www.bureauveritas.dk
 +45 7731 1000



Oasis Sand Hut with Two Tables

NRO526

* Max fall height | ** Total height | *** Safety surfacing area

* Max fall height | ** Total height

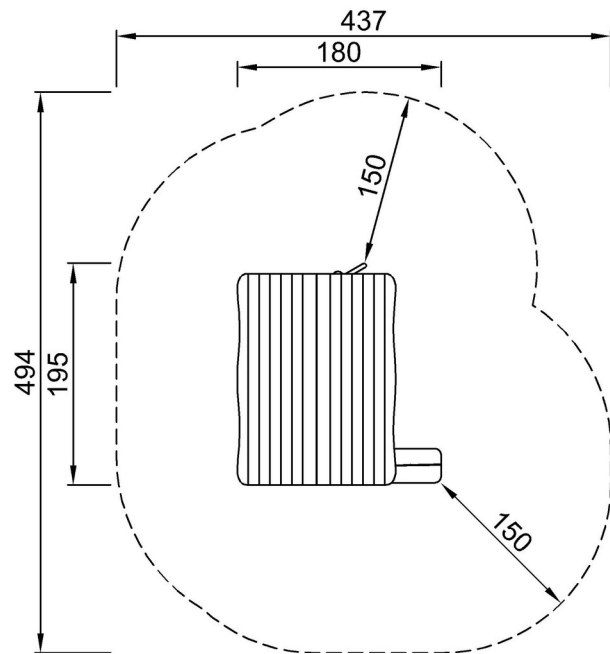

NRO526
**248cm
***17.5m²

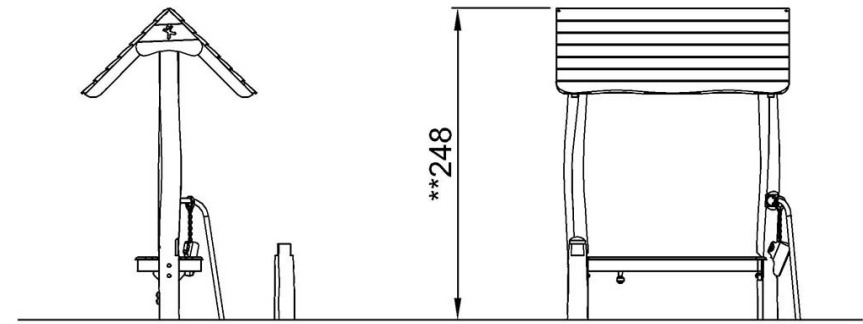

NRO526

[Click to see TOP VIEW](#)

[Click to see SIDE VIEW](#)