

Medite with House Membrane

COR10511

KOMPANI
Let's play

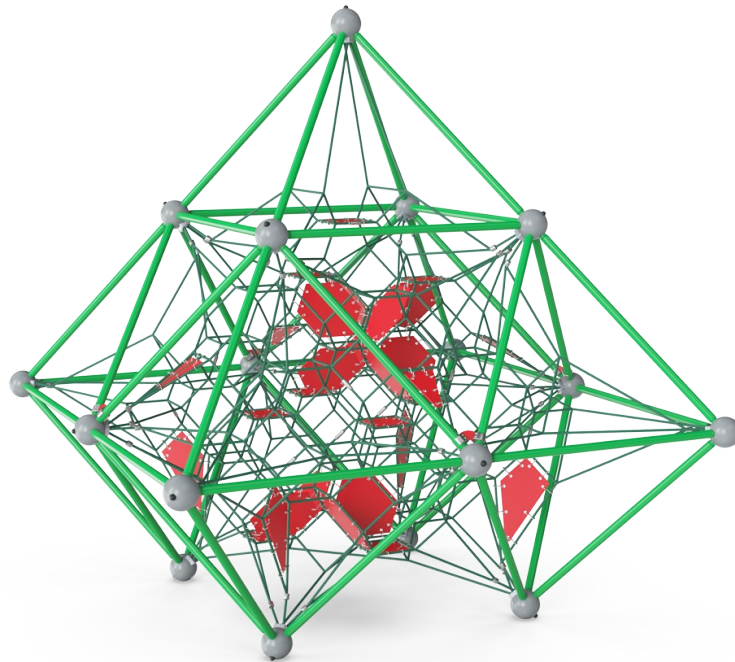

Item no. COR105111-0403	
General Product Information	
Dimensions LxWxH	423x423x446 cm
Age group	5+
Play capacity (users)	31
Colour options	

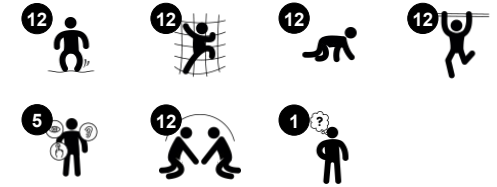

The Medite with House Membrane offers a climbing experience in three-dimensional nets. The meandering, bouncy climbing paths are enjoyable for children with exciting heights, and transparency of action making them want to engage with the playscape for longer. Membranes add fast, bouncy routes to the top and function as destinations and meeting

points. Social interaction and stimulation of cooperation are encouraged here. The bouncy ropes and nets of the Medite add thrill: the child can feel its own and all their friends' movements when using the net. At this height that means risk assessment and concentration. The nets train important motor skills such as proprioception, spatial awareness, and cross-

body coordination. These skills are fundamental for risk assessment when for instance judging and navigating traffic securely.

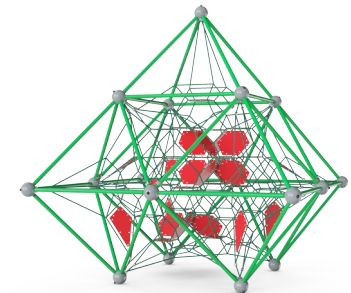

Medite with House Membrane

COR10511

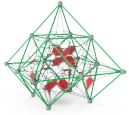

Height

Social-Emotional: children develop courage and self-regulation when being up high. This positively affects self-confidence.

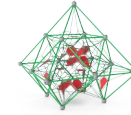
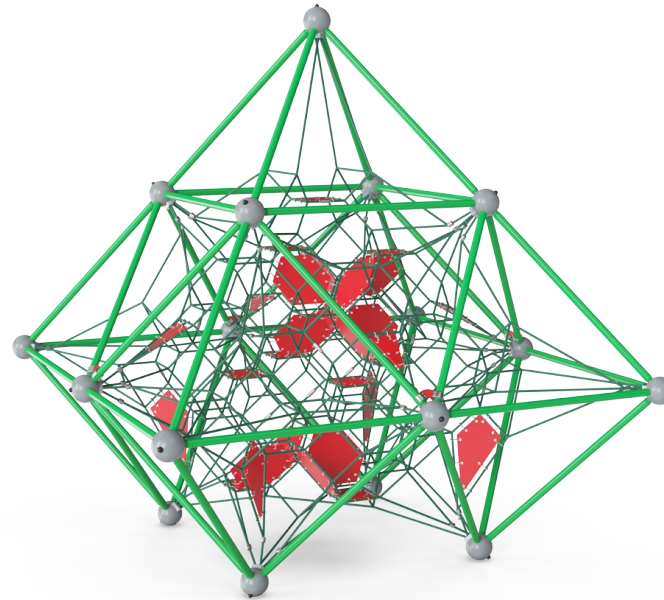

Big meshes

Physical: the big meshes allow for climbing and crawling, supporting proprioception, cross coordination and spatial awareness. **Social-Emotional:** allow more children being seated together, sharing.

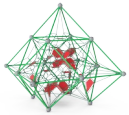

Connected nets

Physical: the connected nets make the climbers feel the movements of the other climbers. All muscle groups are trained, as well as cross coordination. **Social-Emotional:** the climbers' movements affect the other climbers, so consideration and turn-taking is supported.

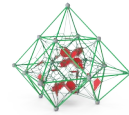

Membrane path

Physical: a faster way up, due to the extra support of the membrane. **Social-Emotional:** a meeting path with points for retreat from the rope landscape.

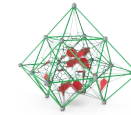

Transparency

Social-Emotional: the transparency makes cooperation and communication possible, which are essential life skills for children to learn.

Medite with House Membrane

COR10511



Designed to allow the typical function of rope play structures to move Corocord 'S' clamps are used as universal connections in Corocord products. 8mm stainless steel rods with rounded edges are pressed around the ropes with a special hydraulic press, making them the ideal connector. Our clamps are safe, durable and vandalism-proof.



The aluminium swages of the net are double conical with rounded ends and are as small as safety allows. The overall net design aims at keeping metal parts within the net to an absolute minimum, both in size and number, to provide the best possible rope climbing experience.

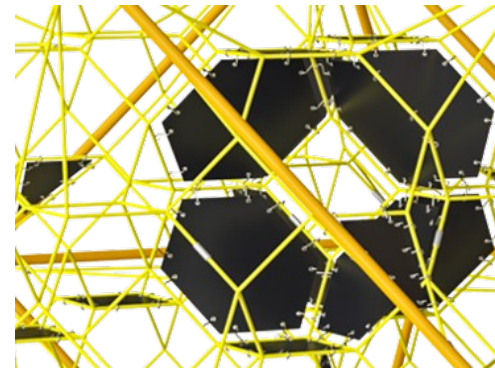

Corocord membranes consist of friction-proof rubberised material of conveyor belt quality with excellent UV resistance. Tested and compliant with REACH requirements for PAH. Embedded is a four-layered armouring made of woven polyester. The armouring and the two surface layers result in a total thickness of 7.5 mm.



The metal parts are made from high-quality steel consisting of hot-dip galvanisation on both the inside and outside and also includes lead-free zinc and an additional layer of powder coating. This ensures both excellent corrosion resistance and colourful design expression.

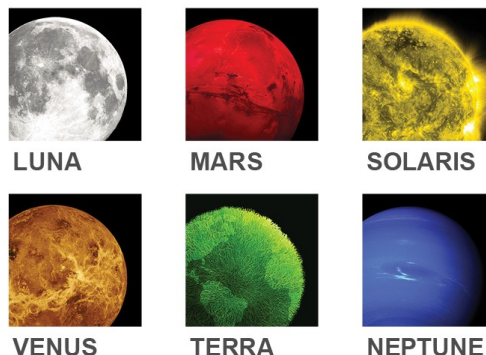

The COROCORD Frame Nets are available in 8 colour themes, ranging from elegant to expressive black or a natural neutral sand colour section to bright eye-catching signal colours which appeals to children of all ages.

Item no. COR105111-0403	
Installation Information	
Max. fall height	165 cm
Safety surfacing area	51.7 m ²
Total installation time	29.6
Excavation volume	1.76 m ³
Concrete volume	0.98 m ³
Footing depth (standard)	110 cm
Shipment weight	1,029 kg
Anchoring options	In-ground ✓
Warranty Information	
Corocord (Hercules) Rope	10 years
EcoCore HDPE Membrane	Lifetime
Galvanised Steel	Lifetime
Spare Parts Guarantee	10 years



Sustainability Data

COR10511

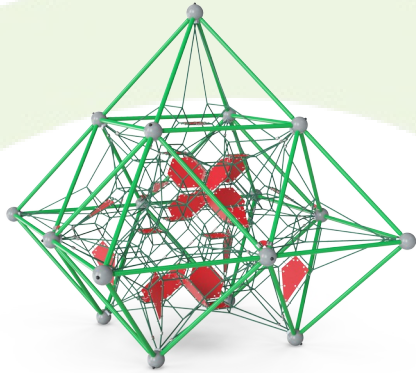

Cradle to Gate A1-A3	Total CO ₂ emission	CO ₂ e/kg	Recycled materials
	kg CO ₂ e	kg CO ₂ e/kg	%
COR105111-0403	2,715.66	3.80	42.33

The overall framework applied for these factors is the Environmental Product Declaration (EPD), which quantifies "environmental information on the life cycle of a product and enable comparisons between products fulfilling the same function" (ISO, 2006). This follows the structure and applies a Life-Cycle Assessment approach to the entire Product stage from raw material through manufacturing (A1-A3))

Kompan A/S
 C.F. Tietgens Boulevard 32C
 DK-5220 Odense SØ
 Denmark



Verification of CO₂ calculation of: Corocord



Data version no. 2023-10-05

The CO₂ calculation and data are in compliance with the principles of a carbon footprint impact according to the GHG protocol (Greenhouse Gas Protocol), Scope 3, cradle to gate related to all individual components in the product category: "Corocord" represented by item no.: COR314011-1101.

(Scope 3 emissions include emission sources in the upstream and downstream value chain).

Date: 30. October 2023 | Valid until: 30. October 2025

Verified by:

Julie Marie Vejsgaard Larsen, LCA & EPD Consultant

Verification based on report: Validation of CO₂ calculation of 9 categories of Kompan product line, version 1.0, prepared by: Bureau Veritas HSE, Denmark: Julie M. V. Larsen.

Publication date: 30. October 2023

By Bureau Veritas HSE
 www.bureauveritas.dk
 +45 7731 1000



Medite with House Membrane

COR10511

* Max fall height | ** Total height | *** Safety surfacing area

* Max fall height | ** Total height

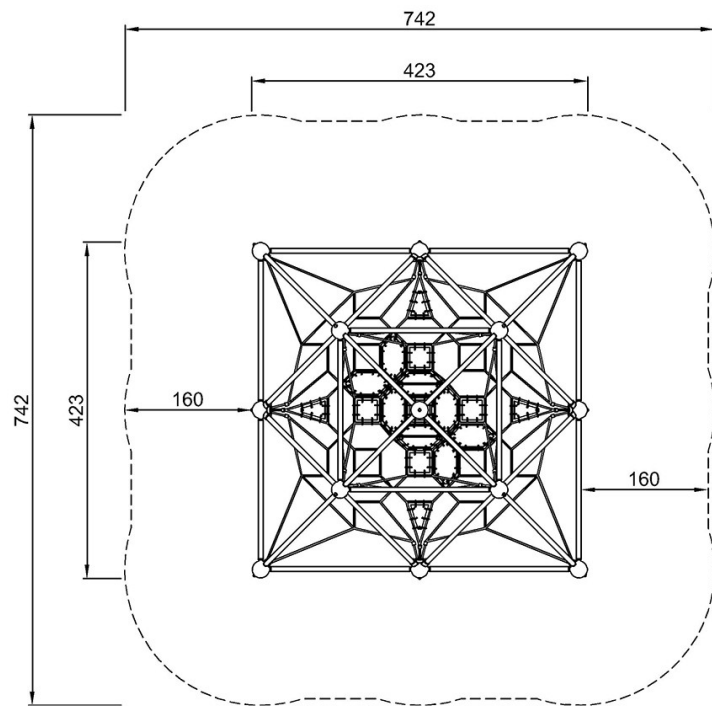

COR10511
*165cm
**446cm
***51.7m²

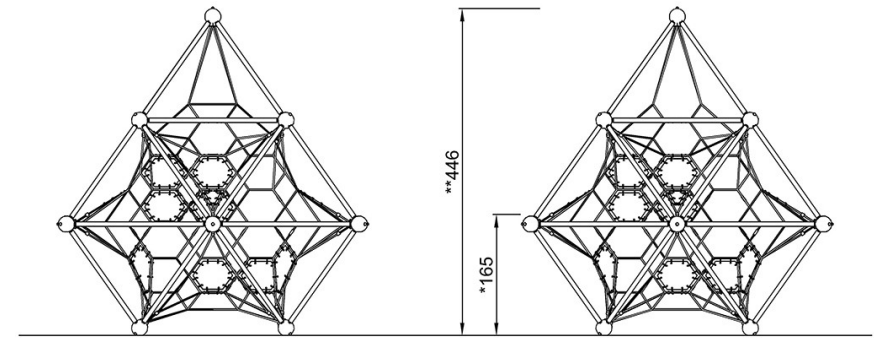

COR10511

[Click to see TOP VIEW](#)

[Click to see SIDE VIEW](#)