

Multi Goal, 12m

FRE601601

KOMPANI
Let's play

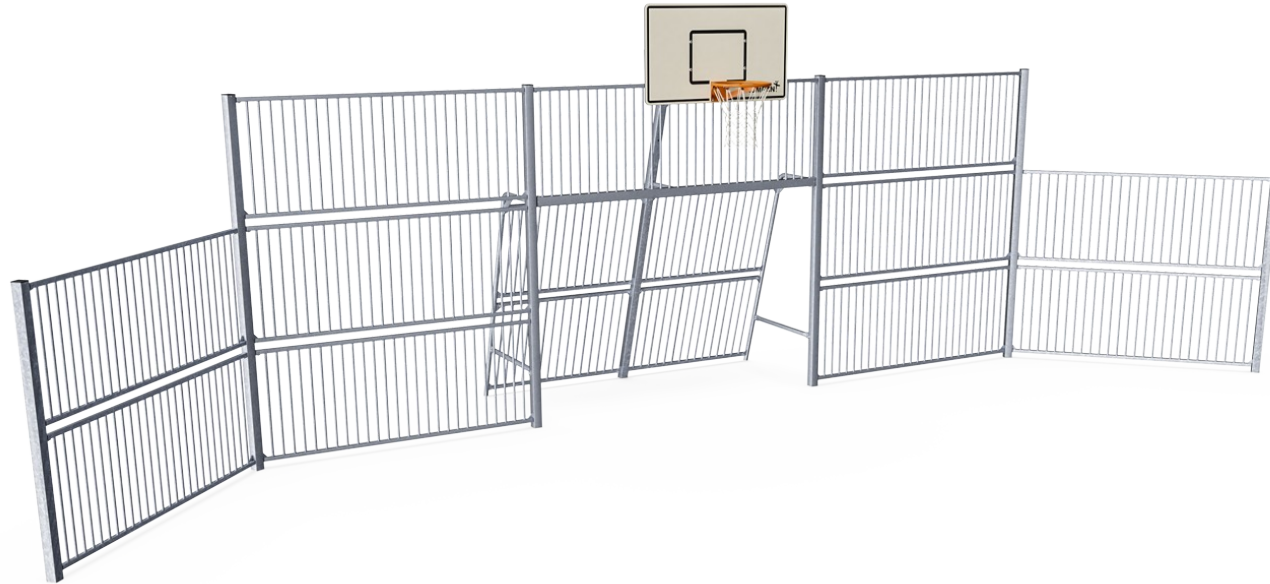

Item no. FRE601601-0901	
General Product Information	
Dimensions LxWxH	326x1186x369 cm
Age group	3+
Play capacity (users)	-
Color options	

The distance between the vertical tubes is small enough to keep small balls, such as field hockey balls, inside the pitch at all times. By embedding the tubes into the steel frame we have created an extremely vandalism proof structure that can be placed in any community. This transparent design makes it easy to follow the game for spectators. The 3 m x 2 m Multi

Goal follows the goal size of FIFA Futsal and IHF Handball regulations. The basketball hoop is placed at the official NBA height of 305 cm, and has the official NBA size of 46 cm in diameter.

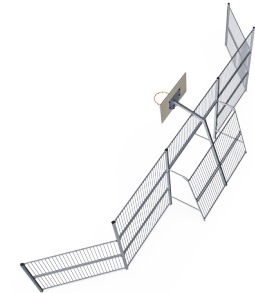

Multi Goal, 12m

FRE601601



The Ø21.3 mm x 2 mm tubes are embedded in the steel panel which avoids cracks and prevent the tubes from braking out of the steel frame. Creating an extremely strong, vandalism proof solution.



All steel components are manufactured from carbon steel, welding's according EN ISO 5817 & Hot dip galvanised (HDG) according to ISO1461. This process ensures good protection in all circumstances.



The posts are made of 80 x 80 x 3mm profile with horizontally, 6mm welded flanges. This will enable an easy installation and strong construction. The low-density polyethylene post caps are attached with blind rivets.

Item no. FRE601601-0901

Installation Information

Max. fall height	0 cm
Safety surfacing area	0.0 m ²
Total installation time	13.5
Excavation volume	0.94 m ³
Concrete volume	0.64 m ³
Footing depth (standard)	85 cm
Shipment weight	859 kg
Anchoring options	In-ground ✓ Surface ✓

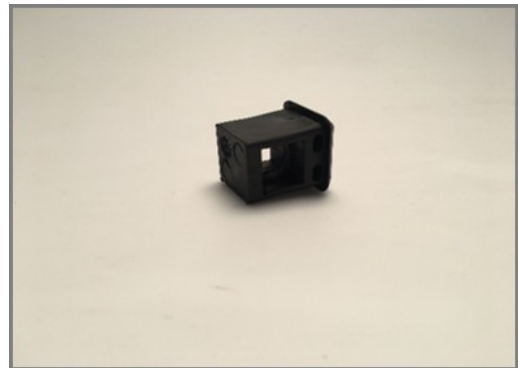

Each panel has 4 Thermoplastic Vulcanizates plugs connecting the panels to the posts. The plugs reduce the vibration and therefore reduce the noise level. The plugs will also simplify installation as the come with pre-assembled nuts.

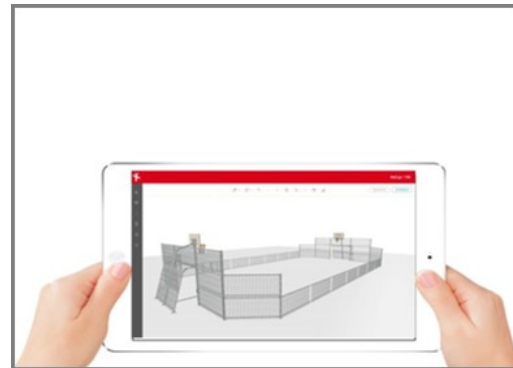

KOMPAN Multi Use Games Areas (MUGA) are designed as a flexible system. With the configurator you can easily change size, height, panels, entrances and goals to create a MUGA that fits your environment, budget and purpose.

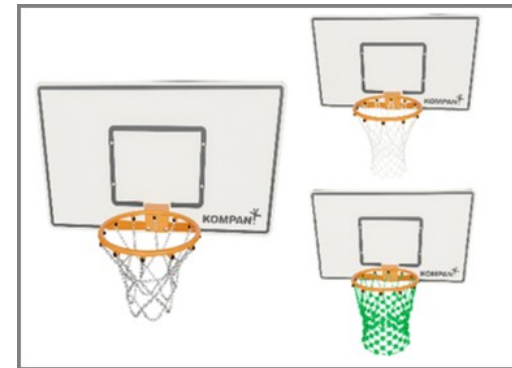

3 choices of nets: Polyamide (PA), PA reinforced with a steel wire inside, stainless steel chains which meet the requirements in ISO1434-ISO1435 and DIN766.



Sustainability Data

FRE601601

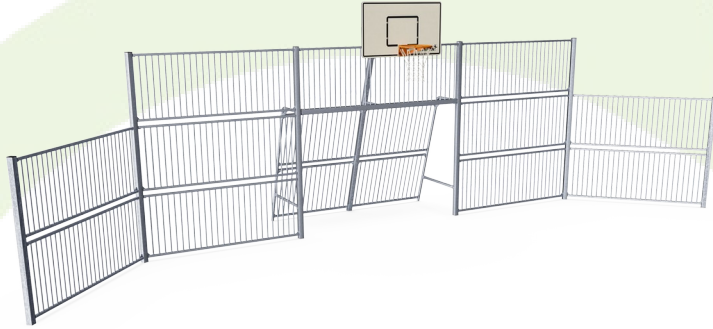

Cradle to Gate A1-A3	Total CO ₂ emission	CO ₂ e/kg	Recycled materials
	kg CO ₂ e	kg CO ₂ e/kg	%
FRE601601-0901	2,037.40	2.54	51.00

The overall framework applied for these factors is the Environmental Product Declaration (EPD), which quantifies "environmental information on the life cycle of a product and enable comparisons between products fulfilling the same function" (ISO, 2006). This follows the structure and applies a Life-Cycle Assessment approach to the entire Product stage from raw material through manufacturing (A1-A3))

Kompan A/S
 C.F. Tietgens Boulevard 32C
 DK-5220 Odense SØ
 Denmark



Verification of CO₂ calculation of: Sport



Data version no. 2023-10-05

The CO₂ calculation and data are in compliance with the principles of a carbon footprint impact according to the GHG protocol (Greenhouse Gas Protocol), Scope 3, cradle to gate related to all individual components in the product category: "Sport" represented by item no.: FRE600202-0901.

(Scope 3 emissions include emission sources in the upstream and downstream value chain).

Date: 30. October 2023 | Valid until: 30. October 2025

Verified by:

Julie Marie Vejsgaard Larsen, LCA & EPD Consultant

Verification based on report: Validation of CO₂ calculation of 9 categories of Kompan product line, version 1.0, prepared by: Bureau Veritas HSE, Denmark: Julie M. V. Larsen.

Publication date: 30. October 2023

By Bureau Veritas HSE
 www.bureauveritas.dk
 +45 7731 1000



Multi Goal, 12m

FRE601601

* Max fall height | ** Total height | *** Safety surfacing area

* Max fall height | ** Total height

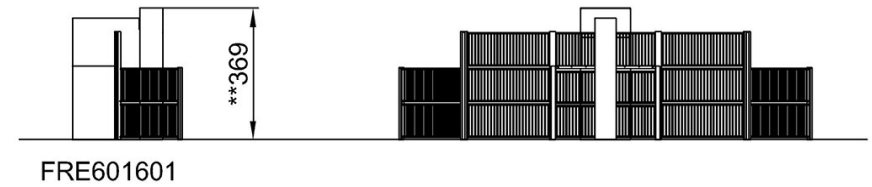
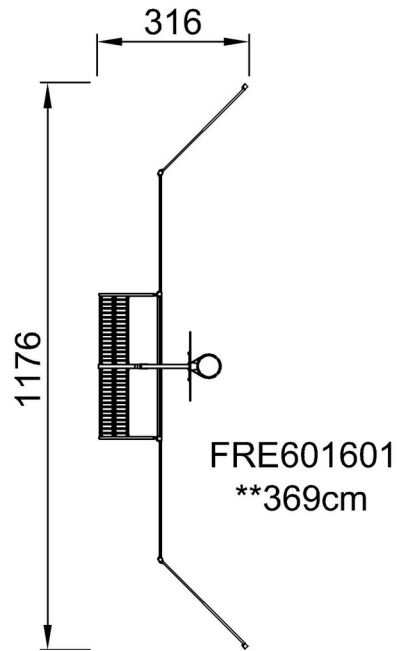

[Click to see TOP VIEW](#)

[Click to see SIDE VIEW](#)