

Rumba Bench End Table - Round

PAR1017



Item no. PAR1017-01	
General Product Information	
Dimensions LxWxH	52x40x8 cm
Age group	-
Play capacity (users)	-
Colour options	●



RUMBA comes with endless possibilities to realize seating in customized design for all outdoor environments. RUMBA is the most flexible way of marrying seating solutions to the environment, in perfect harmony - geometry meets geography. Built around simple circles and curves, they can be adapted to provide custom-built twists and turns. The standard

available benches and tables can be dressed up with back supports, armrests, tables etc. and linked together into tailored solutions for the individual location.

Rumba Bench End Table - Round

PAR1017

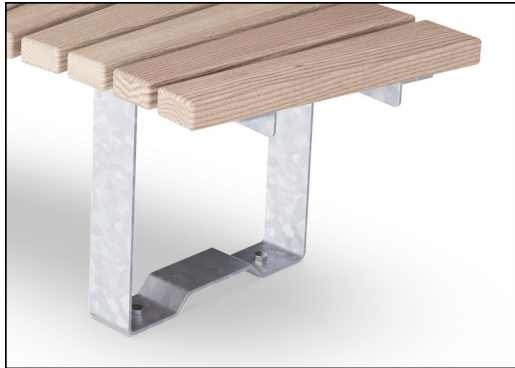

The steel surfaces are hot dip galvanized inside and outside with lead free zinc. The galvanization has excellent corrosion resistance in outdoor environments and require low maintenance.

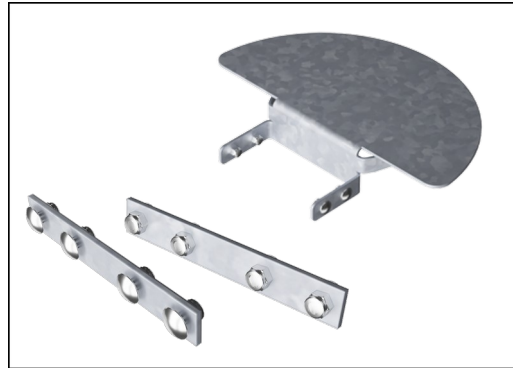

The hardware is made of stainless steel or galvanized steel to ensure durable connections with a high corrosion resistance.



The standard available benches and tables can be dressed up with back support, armrests, tables etc. and linked together into tailored solutions for the individual location.

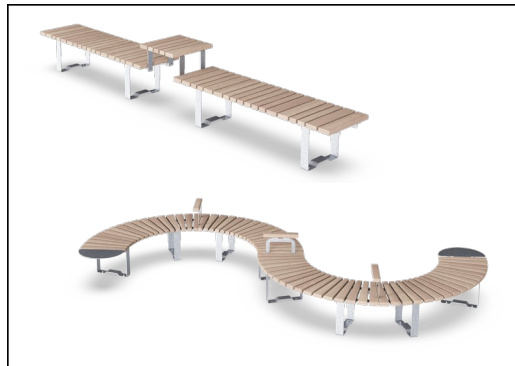

The benches and tables can be combined in multiple settings by choosing individual products or assembled into larger solutions. See catalogue pages for more inspiration.

Item no. PAR1017-01	
Installation Information	
Total installation time	0.2
Excavation volume	0.00 m ³
Concrete volume	0.00 m ³
Footing depth (standard)	0 cm
Shipment weight	7 kg
Anchoring options	
Warranty Information	
Hot dip galvanised steel	Lifetime
Spare parts guaranteed	10 years
Stainless steel components	Lifetime

Sustainability Data

PAR1017

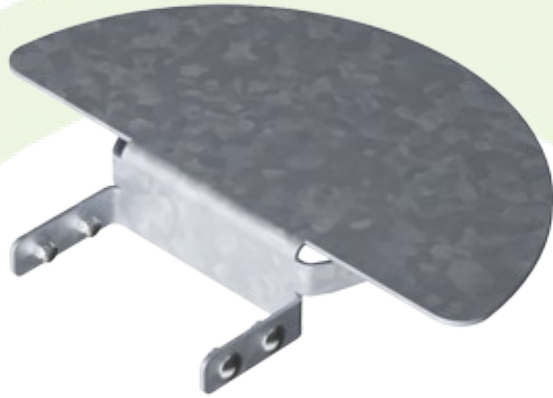

Cradle to Gate A1-A3	Total CO ₂ emission	CO ₂ e/kg	Recycled materials
	kg CO ₂ e	kg CO ₂ e/kg	%
PAR1017-01	14.85	2.61	50.00

The overall framework applied for these factors is the Environmental Product Declaration (EPD), which quantifies "environmental information on the life cycle of a product and enable comparisons between products fulfilling the same function" (ISO, 2006). This follows the structure and applies a Life-Cycle Assessment approach to the entire Product stage from raw material through manufacturing (A1-A3))

Kompan A/S
 C.F. Tietgens Boulevard 32C
 DK-5220 Odense SØ
 Denmark



Verification of CO₂ calculation of: Park



Data version no. 2023-10-05

The CO₂ calculation and data are in compliance with the principles of a carbon footprint impact according to the GHG protocol (Greenhouse Gas Protocol), Scope 3, cradle to gate related to all individual components in the product category: "Park" represented by item no.: PAR4070-0001.

(Scope 3 emissions include emission sources in the upstream and downstream value chain).

Date: 30. October 2023 | Valid until: 30. October 2025

Verified by:

Julie Marie Vejsgaard Larsen, LCA & EPD Consultant

Verification based on report: Validation of CO₂ calculation of 9 categories of Kompan product line, version 1.0, prepared by: Bureau Veritas HSE, Denmark: Julie M. V. Larsen.

Publication date: 30. October 2023

By Bureau Veritas HSE
 www.bureauveritas.dk
 +45 7731 1000

