

Cableway, sloping ground, slide length 25m

M87211

Item no. M87211-3817

General Product Information

Dimensions LxWxH	3320x300x295 cm
Age group	4+
Play capacity (users)	1
Colour options	●



The Large Cableway is the ultimate dare devil attraction. It may attract less evident risk profiles too: with its length and supportive seat and handhold, anyone can participate. And they will, again and again. The reason for this immense holding power lies mainly in the immense thrill of gliding through the air. The feeling of weightlessness and the floating

through the air at speed trains spatial awareness as well as the child's understanding of gravity, space and speed. This is necessary e.g. in managing traffic safely. The social skills get trained as children diligently hand back the seat to the next user in line. The running and pulling involved in this trains the child's cardio as well as upper body muscles.

All in all, the large cableway is an asset of play that unites generations and abilities as there is some way for almost everyone to use it.

Cableway, sloping ground, slide length 25m

M87211



Dino seat

Physical: the three divisions and chains of the seat provide efficient handholds for both standing and seated swinging. **Social-Emotional:** the possibility of children swinging together, legs hanging down, trains cooperation, sequencing and turn-taking when swinging.



PUR covered rope

Physical: firm grip when spinning and hanging from arms. Arm muscles developed when holding tight.



Long line

Physical: the lengthy glide through the air adds to the thrill and trains spatial awareness, trunk stability and upper-body muscles. All this helps support the child's physical self esteem, making e.g. positive risk taking easier.

Cableway, sloping ground, slide length 25m

M87211



The steel surfaces are hot dip galvanised inside and outside with lead free zinc. The galvanisation has excellent corrosion resistance in outside environments and requires low maintenance.



The special designed seat is made of a stainless-steel insert covered with a soft layer of PUR rubber. The seat is impact tested to fulfill all global playground standards and the rope has an ergonomic handhold of a 100cm long moulded on PUR rubber handle.



The high-quality steel cable with a diameter of 12mm is designed for heavy usage of the cableway for many years. The starting point is indicated by a knob. At the stop point there is special designed spring device ensuring a softer stop of the puller.

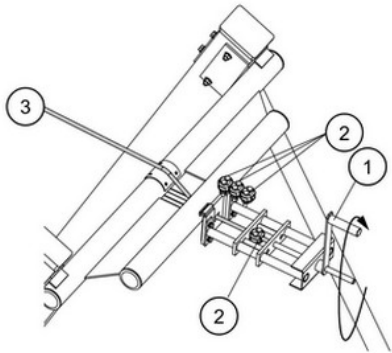

The steel cable 3 is tensioned by a special designed device. By turning the handle 1 the steel cable can be tensioned according to instruction in a safe way. After tensioning the cable is locked by three clamps 2. The tensioning device can also be used for adjustment during annual inspections.

Item no. M87211-3817	
Installation Information	
Max. fall height	100 cm
Safety surfacing area	118.9 m ²
Total installation time	10.1
Excavation volume	6.36 m ³
Concrete volume	1.54 m ³
Footing depth (standard)	100 cm
Shipment weight	362 kg
Anchoring options	In-ground ✓
Warranty Information	
Cable	10 years
Hot dip galvanised steel	Lifetime
Movable parts	2 years
PUR components	10 years
Spare parts guaranteed	10 years



Sustainability Data

M87211

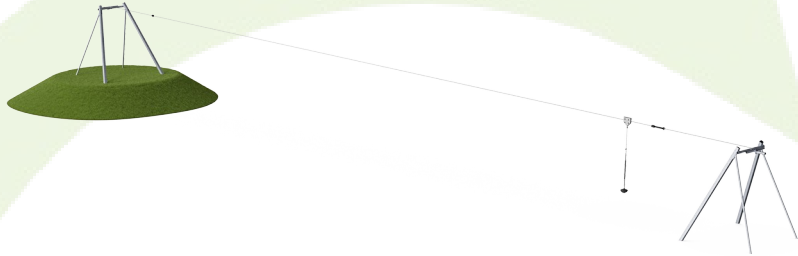

Cradle to Gate A1-A3	Total CO ₂ emission	CO ₂ e/kg	Recycled materials
	kg CO ₂ e	kg CO ₂ e/kg	%
M87211-3817	938.76	2.60	49.75

The overall framework applied for these factors is the Environmental Product Declaration (EPD), which quantifies "environmental information on the life cycle of a product and enable comparisons between products fulfilling the same function" (ISO, 2006). This follows the structure and applies a Life-Cycle Assessment approach to the entire Product stage from raw material through manufacturing (A1-A3))

Kompan A/S
 C.F. Tietgens Boulevard 32C
 DK-5220 Odense SØ
 Denmark



Verification of CO₂ calculation of: Freestanding play equipment



Data version no. 2023-10-05

The CO₂ calculation and data are in compliance with the principles of a carbon footprint impact according to the GHG protocol (Greenhouse Gas Protocol), Scope 3, cradle to gate related to all individual components in the product category: "Freestanding play equipment" represented by item no.: KSW92011-0910.

(Scope 3 emissions include emission sources in the upstream and downstream value chain).

Date: 30. October 2023 | Valid until: 30. October 2025

Verified by:

Julie Marie Vejsgaard Larsen, LCA & EPD Consultant

Verification based on report: Validation of CO₂ calculation of 9 categories of Kompan product line, version 1.0, prepared by: Bureau Veritas HSE, Denmark: Julie M. V. Larsen.

Publication date: 30. October 2023

By Bureau Veritas HSE
 www.bureauveritas.dk
 +45 7731 1000



Cableway, sloping ground, slide length 25m

M87211

* Max fall height | ** Total height | *** Safety surfacing area

* Max fall height | ** Total height

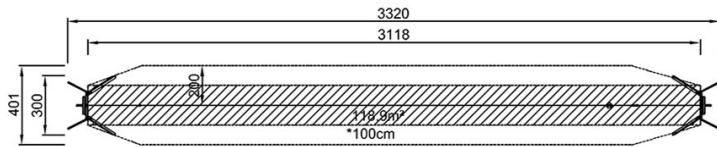

M87211
*100cm
**295cm
***118.9m²

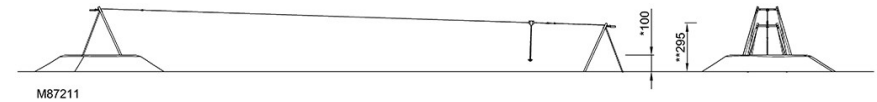

[Click to see TOP VIEW](#)

[Click to see SIDE VIEW](#)