

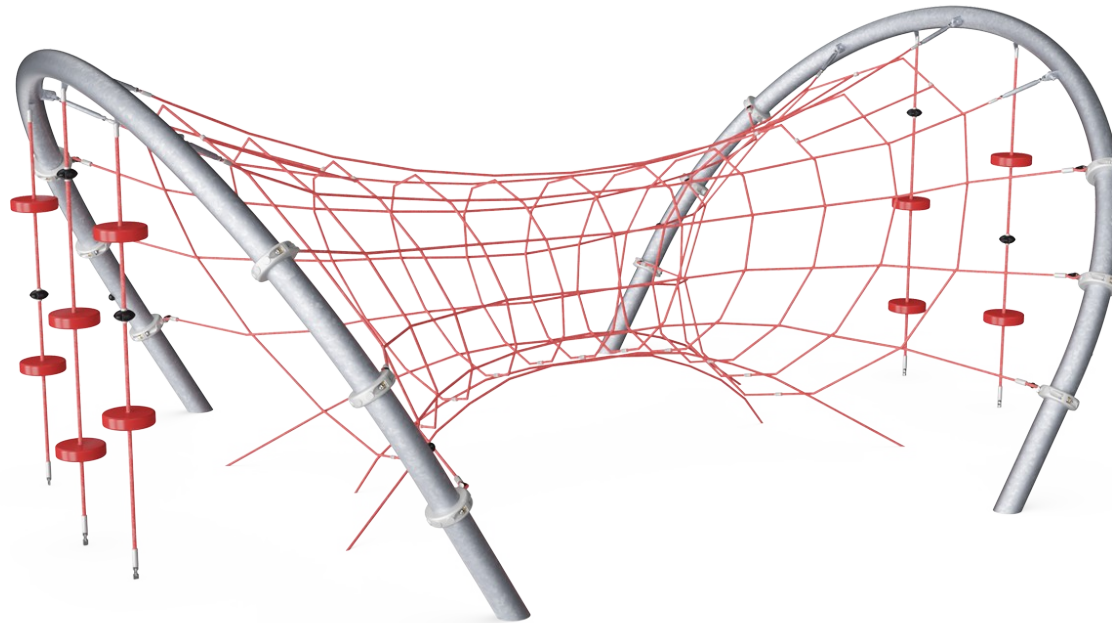



# Arch Tunnel

COR20600



Item no. COR206001-1101	
<b>General Product Information</b>	
Dimensions LxWxH	590x420x250 cm
Age group	5+
Play capacity (users)	17
Color options	  

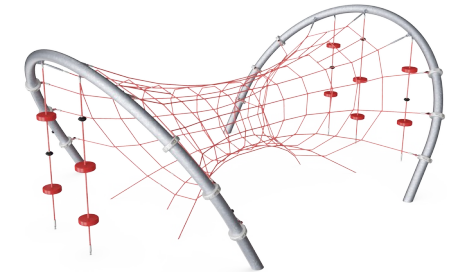
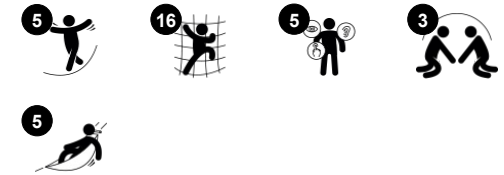

The Arc Tunnel is a three dimensional wobbly climbing structure with stand-out rounded steel posts to hold the net. The spacious surface of the Arc Tunnel offers hours of play for many children and adults alike with its vertical and horizontal climbing. The structure is a great place for sitting, standing or lying which allows everyone to play together. The play ropes with

rubber discs provide a place for groups to socialise while gently swaying on the ropes and the transparency makes social play possible throughout the net. While climbing up, around and through the Arc Tunnel, children's physical skills (balance, muscle strength and cross coordination) are challenged.

# Arch Tunnel

COR20600

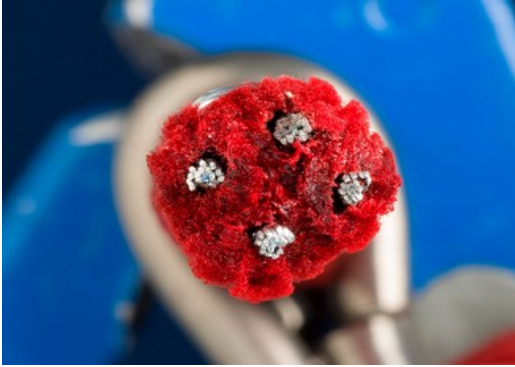

Corocord 16mm ropes of UV-stabilized PES rope strands with inner steel cable reinforcement. The polyester yarn is made from +95% post-consumer materials and is inductively melted onto each strand. The ropes are highly wear-and vandalism-resistant and can be replaced at site if needed.



Corocord 'S' clamps are used as universal connections in Corocord products. 8mm stainless steel rods with rounded edges are pressed around the ropes with a special hydraulic press, making them the ideal connector: safe, durable and vandalism-proof, all while allowing the typical movement of rope play structures.



Fully coloured EPDM rubber discs with smooth surface. The moulded EPDM surrounds a hot dip galvanised steel core that ensures both the stability of the discs and durable fixation to the rope.

Item no. COR206001-1101	
Installation Information	
Max. fall height	250 cm
Safety surfacing area	72.1 m <sup>2</sup>
Total installation time	33.1
Excavation volume	6.73 m <sup>3</sup>
Concrete volume	4.71 m <sup>3</sup>
Footing depth (standard)	110 cm
Shipment weight	810 kg
Anchoring options	In-ground ✓



Corocord aluminium clamps are used as connectors between steel posts and rope. Two aluminium castings are bolted together. The height of the clamps is thus variable.



The steel arches are hot dip galvanised inside and outside with lead free zinc. The galvanisation has excellent corrosion resistance in outside environments and requires low maintenance.



# Sustainability Data

COR20600

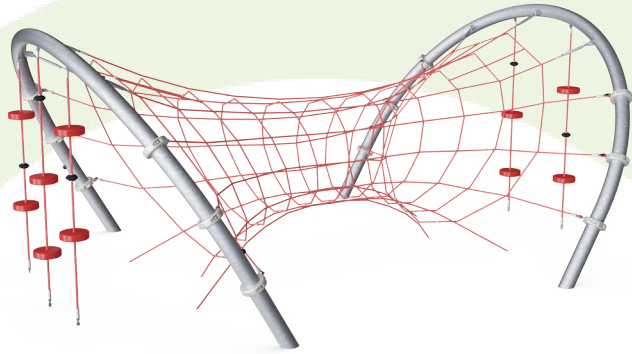

Cradle to Gate A1-A3	Total CO <sub>2</sub> emission	CO <sub>2</sub> e/kg	Recycled materials
	kg CO <sub>2</sub> e	kg CO <sub>2</sub> e/kg	%
<b>COR206001-1101</b>	2,165.30	3.07	44.40

The overall framework applied for these factors is the Environmental Product Declaration (EPD), which quantifies "environmental information on the life cycle of a product and enable comparisons between products fulfilling the same function" (ISO, 2006). This follows the structure and applies a Life-Cycle Assessment approach to the entire Product stage from raw material through manufacturing (A1-A3))

**Kompan A/S**  
 C.F. Tietgens Boulevard 32C  
 DK-5220 Odense SØ  
 Denmark



## Verification of CO<sub>2</sub> calculation of: Corocord



Data version no. 2023-10-05

The CO<sub>2</sub> calculation and data are in compliance with the principles of a carbon footprint impact according to the GHG protocol (Greenhouse Gas Protocol), Scope 3, cradle to gate related to all individual components in the product category: "Corocord" represented by item no.: COR314011-1101.

(Scope 3 emissions include emission sources in the upstream and downstream value chain).

**Date: 30. October 2023 | Valid until: 30. October 2025**

Verified by:

Julie Marie Vejsgaard Larsen, LCA & EPD Consultant

Verification based on report: Validation of CO<sub>2</sub> calculation of 9 categories of Kompan product line, version 1.0, prepared by: Bureau Veritas HSE, Denmark: Julie M. V. Larsen.

**Publication date: 30. October 2023**

By Bureau Veritas HSE  
 www.bureauveritas.dk  
 +45 7731 1000



# Arch Tunnel

COR20600

\* Max fall height | \*\* Total height | \*\*\* Safety surfacing area

\* Max fall height | \*\* Total height

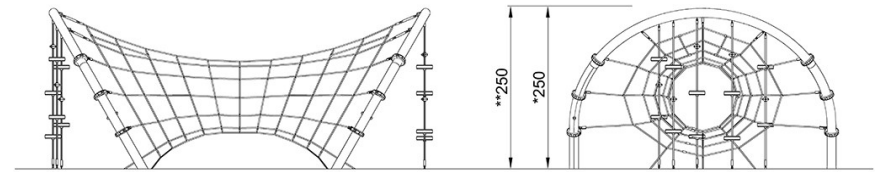
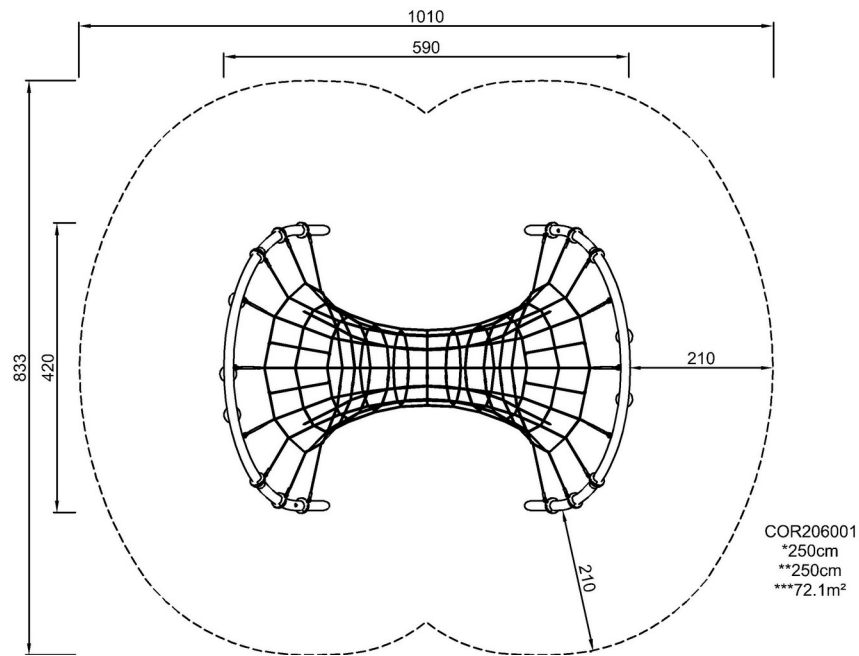

COR206001

[Click to see TOP VIEW](#)

[Click to see SIDE VIEW](#)