

# Home & Rescue

MSC6401

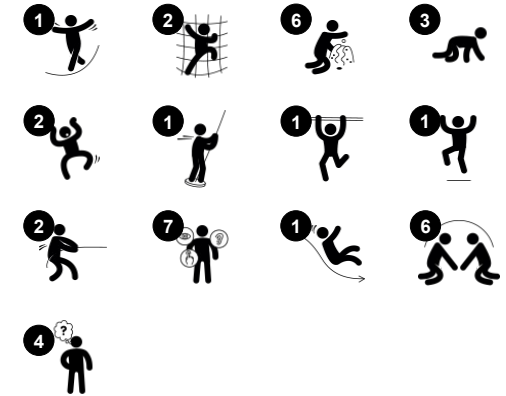

Item no. MSC640100-3717P	
General Product Information	
Dimensions LxWxH	348x425x285 cm
Age group	2+
Play capacity (users)	17
Color options	



WOW! The Home & Rescue themes appeal to children's urge for dramatic play stories. The under-deck den invites a break with friends. There is a Home side and a Rescue side, inspiring play stories. Thanks to the two-sided panels and themes and the varied accesses: curved and inclined, the Home & Rescue challenge a wide user group. The curved

climbing wall, the crawl through tire, and the inclined climbing net in their own fun ways train motor skills such as cross-coordination. This influences the brain's ability to read and write. It Builds up body confidence, too, makes children more secure in moving through the world. The Home & Rescue can be played with on all sides. From the upper level tactile details

encourage communication with the outside. Here children meet, greet and play, making friends for life.

# Home & Rescue

MSC6401



Panels of 19mm EcoCore™. EcoCore™ is a highly durable, eco friendly material, which is not only recyclable after use, but also consists of material produced from +95% recycled post consumer material from food packing waste.

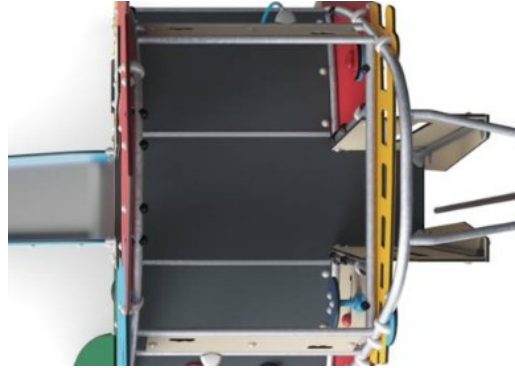

All floors are made of High-Pressure Laminate HPL with a thickness 17.8mm and non skid surface texture according to EN 438-6. KOMPAN HPL has high wearing strength to ensure long lifetime in all climates.

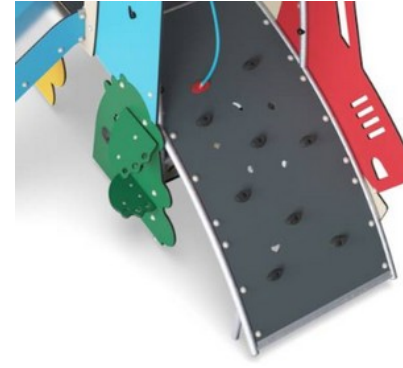

Curved climbing wall is made of Ekogrip® panel that consist of a 15mm thick PE base with 3 mm top-layer of soft rubber with a non-skid effect.

Item no. MSC640100-3717P

## Installation Information

Max. fall height	133 cm
Safety surfacing area	32.0 m <sup>2</sup>
Total installation time	23.3
Excavation volume	0.83 m <sup>3</sup>
Concrete volume	0.00 m <sup>3</sup>
Footing depth (standard)	90 cm
Shipment weight	724 kg
Anchoring options	In-ground ✓ Surface ✓



The slide is made of combined EcoCore™ sides and stainless steel slide bed t=2mm.

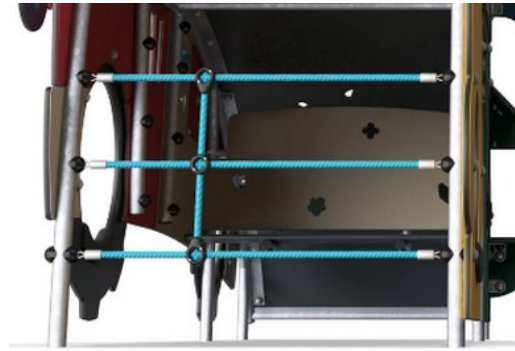

Ropes are made of UV-stabilised PA with inner steel cable reinforcement. The rope is induction treated in order to create a strong connection between steel and rope which leads to good wear resistance.



The steel surfaces are hot dip galvanised inside and outside with lead free zinc. The galvanisation has excellent corrosion resistance in outside environments and requires low maintenance.



# Sustainability Data

MSC6401



Cradle to Gate A1-A3	Total CO <sub>2</sub> emission	CO <sub>2</sub> e/kg	Recycled materials
	kg CO <sub>2</sub> e	kg CO <sub>2</sub> e/kg	%
<b>MSC640100-3717P</b>	1,232.70	2.24	59.10

The overall framework applied for these factors is the Environmental Product Declaration (EPD), which quantifies "environmental information on the life cycle of a product and enable comparisons between products fulfilling the same function" (ISO, 2006). This follows the structure and applies a Life-Cycle Assessment approach to the entire Product stage from raw material through manufacturing (A1-A3))

**Kompan A/S**  
 C.F. Tietgens Boulevard 32C  
 DK-5220 Odense SØ  
 Denmark



## Verification of CO<sub>2</sub> calculation of: Themed play systems



Data version no. 2023-10-05

The CO<sub>2</sub> calculation and data are in compliance with the principles of a carbon footprint impact according to the GHG protocol (Greenhouse Gas Protocol), Scope 3, cradle to gate related to all individual components in the product category: "Themed play systems" represented by item no.: MSC641100-3717P.

(Scope 3 emissions include emission sources in the upstream and downstream value chain).

**Date: 30. October 2023 | Valid until: 30. October 2025**

Verified by:

Julie Marie Vejsgaard Larsen, LCA & EPD Consultant

Verification based on report: Validation of CO<sub>2</sub> calculation of 9 categories of Kompan product line, version 1.0, prepared by: Bureau Veritas HSE, Denmark: Julie M. V. Larsen.

**Publication date: 30. October 2023**

By Bureau Veritas HSE  
 www.bureauveritas.dk  
 +45 7731 1000



# Home & Rescue

MSC6401

\* Max fall height | \*\* Total height | \*\*\* Safety surfacing area

\* Max fall height | \*\* Total height

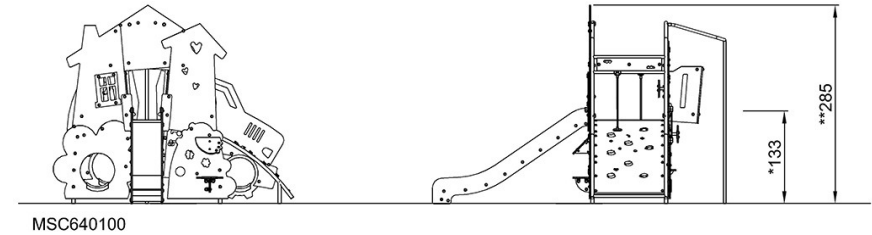
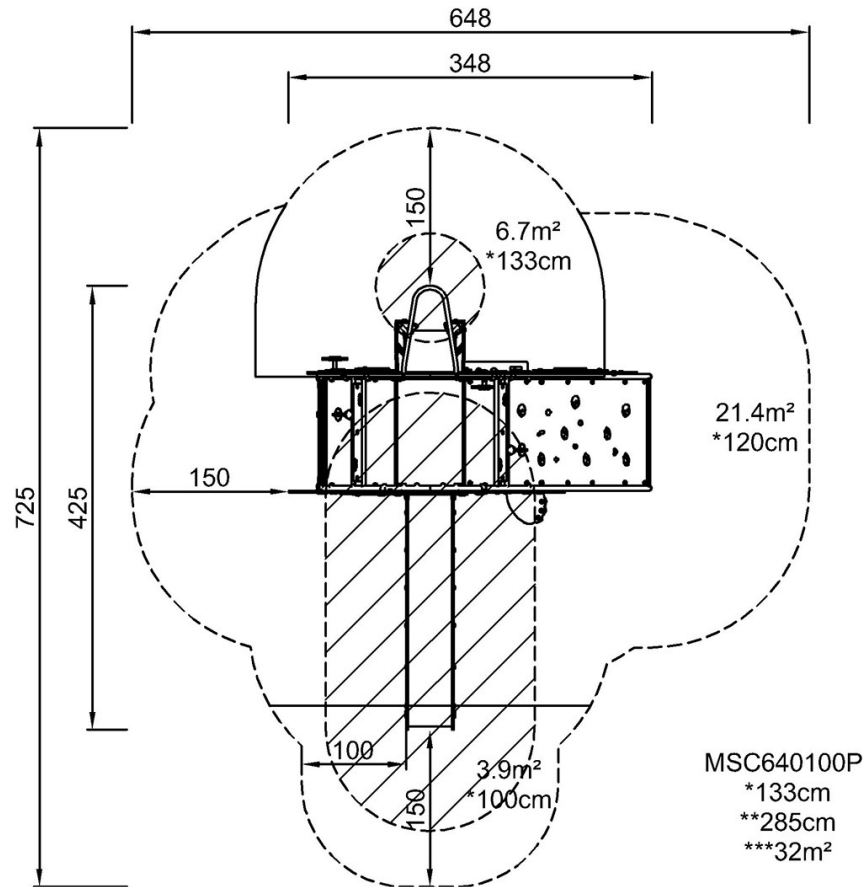

[Click to see TOP VIEW](#)

[Click to see SIDE VIEW](#)