



Triple Tower

KPL3010



Item no. KPL301011-0902	
General Product Information	
Dimensions LxWxH	427x442x376 cm
Age group	4+
Play capacity (users)	19
Color options	 

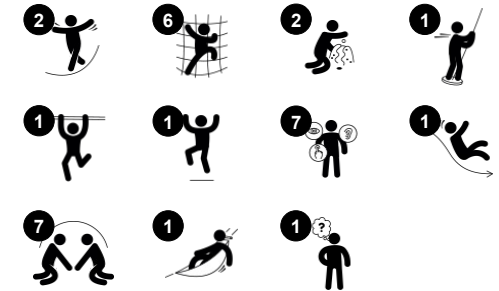

This wonderful combination of fun and challenging play activities creates an irresistible play unit. Children will try it out and come back for more play, again and again. The layers of challenging play add something new to try out in every corner. And the varied play panels on ground level create corners for quieter play breaks also. The tall tower with the

dare devil fireman's pole and the vertical climbing wall is great training of muscles and motor skills for the oldest. It can be accessed also from the inclined balancing beam from the lower tower, creating a truly challenging balance act. The senses of balance and space are trained immensely when playing on the balance beam. When climbing the tall net, the

proprioception and muscles are used intensely. The proprioception is fundamental in navigating the world securely and for judging distances, for instance in traffic.

Triple Tower

KPL3010



Panels of 19mm EcoCore™. EcoCore™ is a highly durable, eco friendly material, which is not only recyclable after use, but also consists of material produced from +95% recycled post consumer material from food packing waste.



The main tower posts are available in two types of material: European pine wood posts, pressure impregnated Class 3 with Tanalith E3475 according to EN335 (Equivalent to NTR Class AB). Aluminum post t=2mm with anodized surface treatment. Base material EN AW-6060 T66.

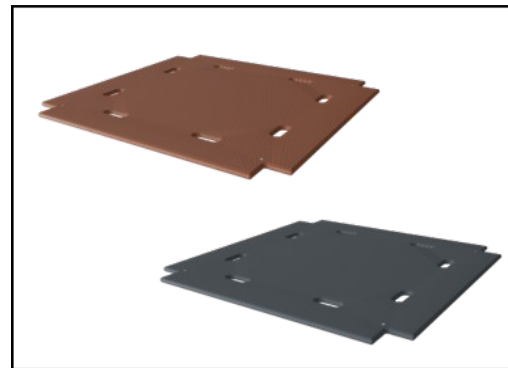

Floors and panel activities are available in two types of material: Waterproof plywood decks thickness 21.5mm from pine and alder wood with anti-slip film on both sides. High Pressure Laminate HPL thickness 17.8mm with slip resistant surface texture according to EN 438-6.

Item no. KPL301011-0902

Installation Information

Max. fall height	178 cm
Safety surfacing area	45.5 m ²
Total installation time	18.1
Excavation volume	1.68 m ³
Concrete volume	0.76 m ³
Footing depth (standard)	90 cm
Shipment weight	594 kg
Anchoring options	In-ground ✓ Surface ✓

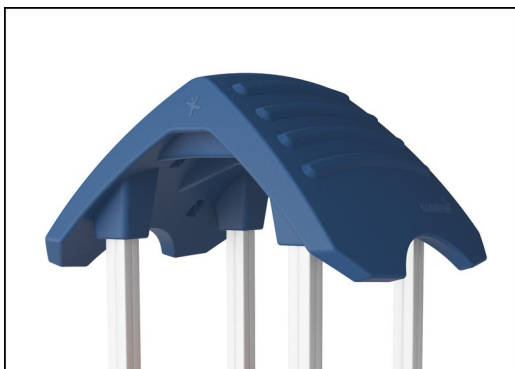

The large hollow components are made of 100% recyclable PE. The roof displayed is moulded in one piece with minimum 5,5mm wall thickness to ensure high durability in all climates around the world.

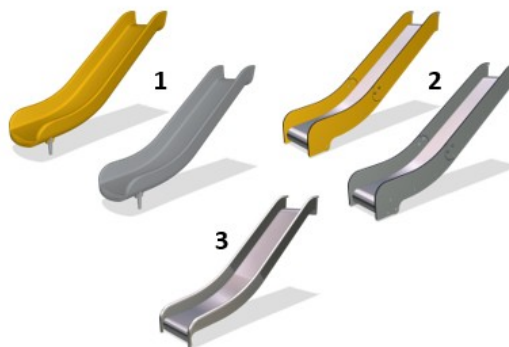

Slides are available in three different materials: moulded on piece PE slides, Combined EcoCore™ sides and stainless steel slide bed t=2mm. Full stainless steel AISI304 t=2mm.



Climbing nets are made of UV-stabilised PP rope with inner steel cable reinforcement. The rope is induction treated to obtain maximum fixation between steel and rope which provides excellent wear and tear resistance. All rope connectors are made of 100% recyclable PA material.



Sustainability Data

KPL3010



Cradle to Gate A1-A3	Total CO ₂ emission	CO ₂ e/kg	Recycled materials
	kg CO ₂ e	kg CO ₂ e/kg	%
KPL301011-0902	657.30	1.48	33.70

The overall framework applied for these factors is the Environmental Product Declaration (EPD), which quantifies "environmental information on the life cycle of a product and enable comparisons between products fulfilling the same function" (ISO, 2006). This follows the structure and applies a Life-Cycle Assessment approach to the entire Product stage from raw material through manufacturing (A1-A3))

Kompan A/S
 C.F. Tietgens Boulevard 32C
 DK-5220 Odense SØ
 Denmark



Verification of CO₂ calculation of: Play systems



Data version no. 2023-10-05

The CO₂ calculation and data are in compliance with the principles of a carbon footprint impact according to the GHG protocol (Greenhouse Gas Protocol), Scope 3, cradle to gate related to all individual components in the product category: "Play systems" represented by item no.: PCM200321-0950.

(Scope 3 emissions include emission sources in the upstream and downstream value chain).

Date: 30. October 2023 | Valid until: 30. October 2025

Verified by:

Julie Marie Vejsgaard Larsen, LCA & EPD Consultant

Verification based on report: Validation of CO₂ calculation of 9 categories of Kompan product line, version 1.0, prepared by: Bureau Veritas HSE, Denmark: Julie M. V. Larsen.

Publication date: 30. October 2023

By Bureau Veritas HSE
 www.bureauveritas.dk
 +45 7731 1000



Triple Tower

KPL3010

* Max fall height | ** Total height | *** Safety surfacing area

* Max fall height | ** Total height

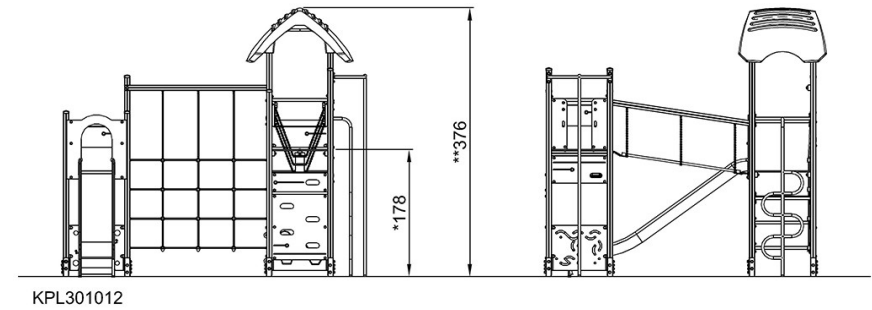
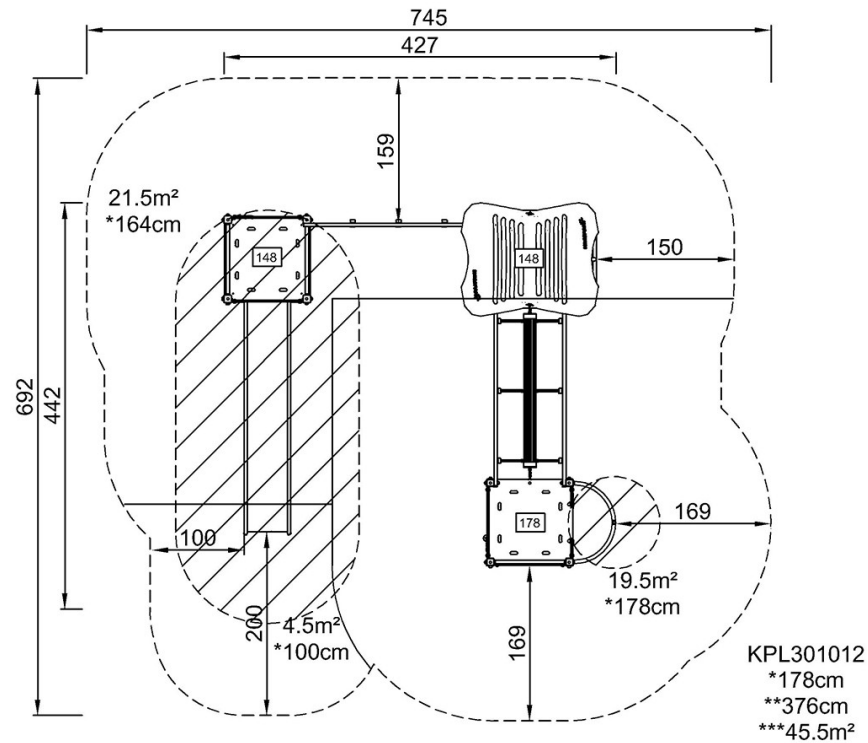

[Click to see TOP VIEW](#)

[Click to see SIDE VIEW](#)