

# Double Tower with Net

PCM212121

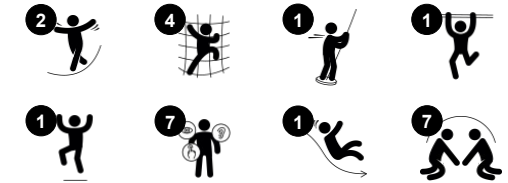

Item no. PCM212121-0905	
General Product Information	
Dimensions LxWxH	654x381x380 cm
Age group	4+
Play capacity (users)	21
Colour options	



The impressive number of play options on the Double Tower with net bridge will inspire children to play again and again. The graded play in diverse climbing only adds to the fun: the cross-coordination and awareness when climbing help the child manage their body confidently and securely through the world. The net bridge gives a high view when the child

balances over, training the perception of distances. The fast slide and even faster fireman's pole are hugely thrilling and train the child's balance and posture in a fun way. The sense of balance is important for the ability to e.g. sit still and concentrate at school. The huge net is fun meeting and invites socialising. The somersault bar adds a ground level

challenge.



# Double Tower with Net

PCM212121



## Fireman's pole

**Physical:** coordination is supported when going down, as well as arm and core muscles. Landing strengthens bone density, which is built for life in early childhood. **Social-Emotional:** turn-taking and risk-taking.



## Climbing net

**Physical:** children develop cross-body coordination and muscle strength when climbing. The big meshes allow for climbing and crawling through, supporting proprioception and spatial awareness. **Social-Emotional:** the big meshes allow for more children to sit together and talk.



## Slide

**Physical:** sliding develops spatial awareness and a sense of balance. Furthermore, the core muscles are trained when sitting upright going down. **Social-Emotional:** empathy stimulated by turn-taking.



## Somersault bar

**Physical:** develop balance and core when hanging from knees. Arm, leg and core muscles are developed when climbing up, somersaulting around. Balance and spatial awareness are strengthened. **Social-Emotional:** meeting, socializing and turn-taking when climbing up and down via bar.



## Accessible stairway

**Physical:** climbing the accessible stairway is for all and supports cross coordination as well as arm and leg muscles. For young children, walking stairs and alternating feet is developed. **Social-Emotional:** room for active breaks and adult helpers. An inclusive space.



## Bench

**Social-Emotional:** gathering, cooperating or taking a break from play - all train social skills.



## Net bridge

**Physical:** children develop their balance, cross coordination and spatial awareness in the open net. **Social-Emotional:** interaction with children outside, socializing. Cooperation and consideration, e.g. when passing others.

# Double Tower with Net

PCM212121



Panels of 19mm EcoCore™. EcoCore™ is a highly durable, eco friendly material, which is not only recyclable after use, but also consists of material produced from +95% recycled post consumer material from food packing waste.



All decks are supported by unique designed low-carbon aluminum profiles with multiple attachment options. The grey colored molded decks are made of 75% post-consumer waste PP material with a non-skid pattern and texture surface.



Main posts with hot dip galvanized steel footing are available in different materials: Pressure impregnated pine wood posts. Pre-galvanized inside and outside with powder coated top finish steel posts. Lead free aluminum with color anodized top finish. Greenline TexMade posts of 95% post-consumer recycled PE and textile waste.

Item no. PCM212121-0905	
Installation Information	
Max. fall height	224 cm
Safety surfacing area	54.7 m <sup>2</sup>
Total installation time	22.2
Excavation volume	0.62 m <sup>3</sup>
Concrete volume	0.12 m <sup>3</sup>
Footing depth (standard)	90 cm
Shipment weight	806 kg
Anchoring options	Surface ✓ In-ground ✓
Warranty Information	
EcoCore HDPE	Lifetime
Post	10 years
PP Decks	10 years
Ropes & nets	10 years
Spare parts guaranteed	10 years

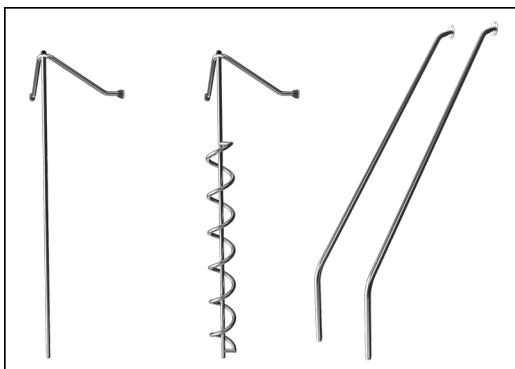

The stainless-steel activities are made of high-quality stainless steel. The steel is cleaned by a total pickling process after manufacturing to ensure a smooth and clean gliding surfaces.



The slides can be chosen in six different colors and three materials: Straight or curved one-piece molded PE slides, made from 33% recycled post-consumer materials in different colours. Combined EcoCore™ sides and stainless-steel. Full stainless steel in one piece design for more vandalism proof solutions.



KOMPAN GreenLine versions are designed with ultimate environmentally friendly materials with lowest possible CO2e emission factor. TexMade post, EcoCore™ panels of 95% post-consumer recycled waste and molded PP decks.



# Sustainability Data

PCM212121



Cradle to Gate A1-A3	Total CO <sub>2</sub> emission	CO <sub>2</sub> e/kg	Recycled materials
	kg CO <sub>2</sub> e	kg CO <sub>2</sub> e/kg	%
<b>PCM212121-0951</b>	1,011.37	1.52	74.05
<b>PCM212121-0905</b>	1,100.12	1.96	66.35

The overall framework applied for these factors is the Environmental Product Declaration (EPD), which quantifies "environmental information on the life cycle of a product and enable comparisons between products fulfilling the same function" (ISO, 2006). This follows the structure and applies a Life-Cycle Assessment approach to the entire Product stage from raw material through manufacturing (A1-A3))

**Kompan A/S**  
C.F. Tietgens Boulevard 32C  
DK-5220 Odense SØ  
Denmark



## Verification of CO<sub>2</sub> calculation of: Play systems



Data version no. 2023-10-05

The CO<sub>2</sub> calculation and data are in compliance with the principles of a carbon footprint impact according to the GHG protocol (Greenhouse Gas Protocol), Scope 3, cradle to gate related to all individual components in the product category: "Play systems" represented by item no.: PCM200321-0950.

(Scope 3 emissions include emission sources in the upstream and downstream value chain).

**Date: 30. October 2023 | Valid until: 30. October 2025**

Verified by:

Julie Marie Vejsgaard Larsen, LCA & EPD Consultant

Verification based on report: Validation of CO<sub>2</sub> calculation of 9 categories of Kompan product line, version 1.0, prepared by: Bureau Veritas HSE, Denmark: Julie M. V. Larsen.

**Publication date: 30. October 2023**

By Bureau Veritas HSE  
www.bureauveritas.dk  
+45 7731 1000



# Double Tower with Net

PCM212121

\* Max fall height | \*\* Total height | \*\*\* Safety surfacing area

\* Max fall height | \*\* Total height

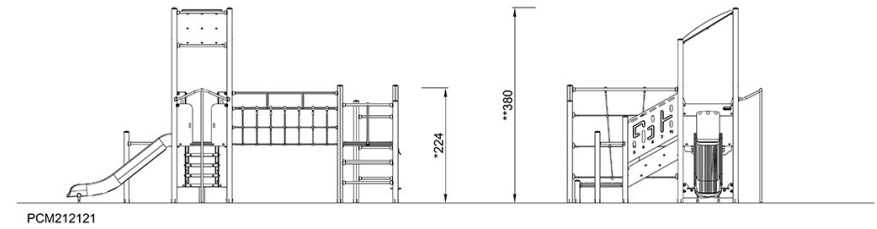
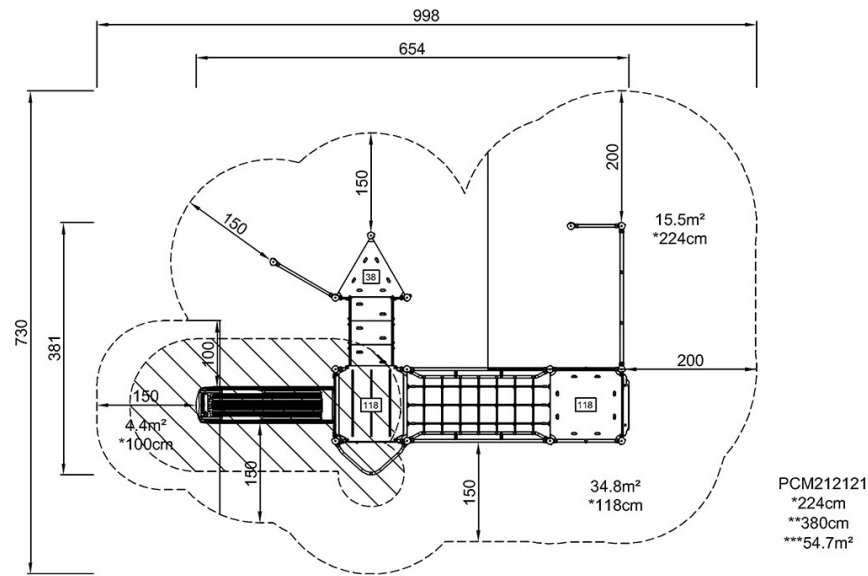

[Click to see TOP VIEW](#)

[Click to see SIDE VIEW](#)