

Jungle & Ocean with Net Tower

MSC6404

产品编号 MSC640400-3717P

产品信息概览

长宽高尺寸	738x433x286 cm
适用年龄段	2+
容纳人数	30
颜色选择	

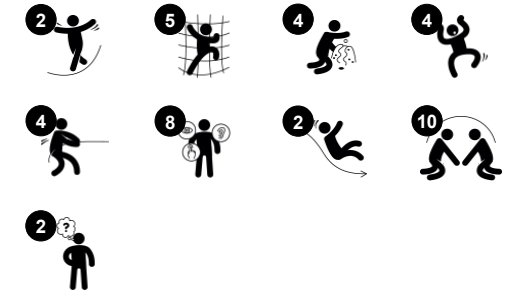
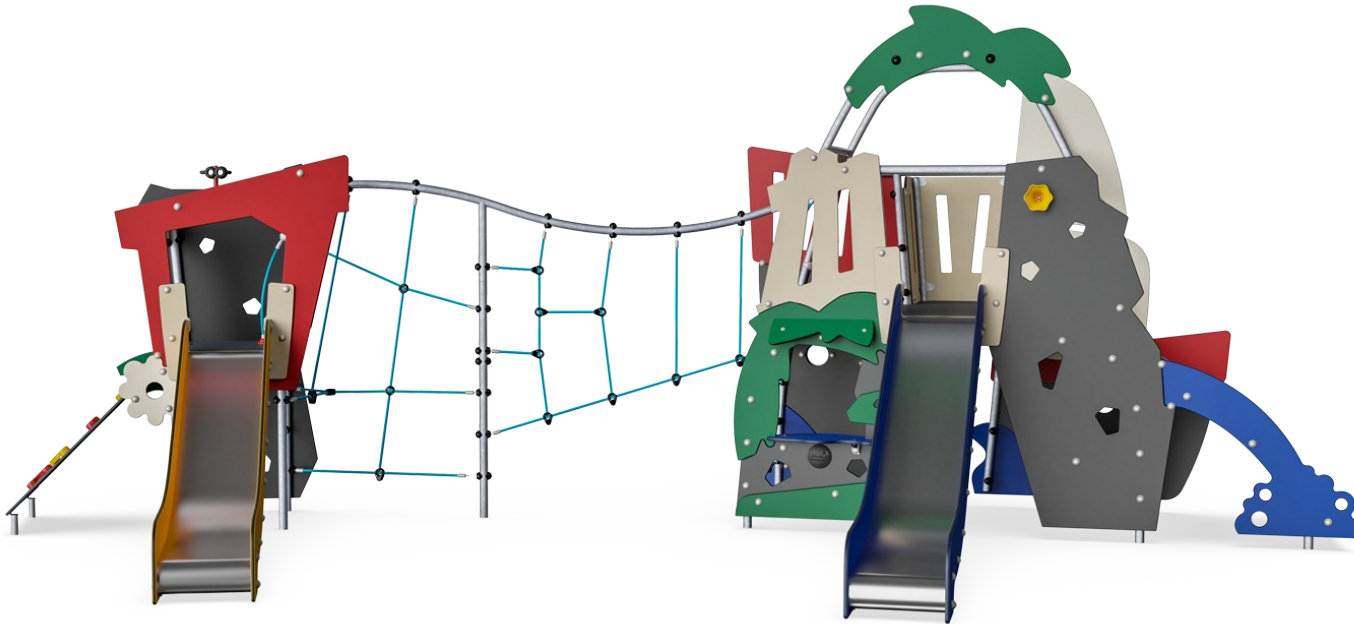

WOW! The roomy Jungle & Ocean themes appeal to children's dramatic play stories. The ground-level den invites a break with friends. There is a Jungle side and an Ocean side, inspiring vigorous play stories. Thanks to the two-sided themed panels and the varied climbers: curved, straight and net climbers, there are challenges for a wide user group. The

climbing events and the slides train motor skills, such as cross-coordination and balance, important for navigating the world confidently. There are many meeting points as the Jungle & Ocean can be played in from all sides. The huge net adds volume and active meeting. From the upper level, children can communicate with those on the ground level.

All in all, the social play invitation in the Jungle & Ocean is immense. Children meet, greet and play, making friends for life.

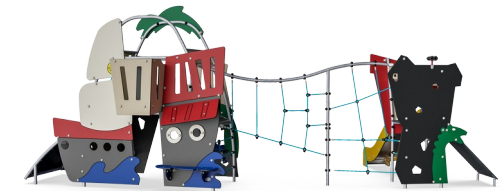

Jungle & Ocean with Net Tower

MSC6404

KOMPANI
Let's play



Megaphone

社交情感：培养沟通和轮流参与的能力。**认知能力：**音调的变换会唤起人们的好奇心，激发人们对因果关系的理解。

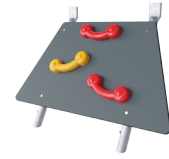
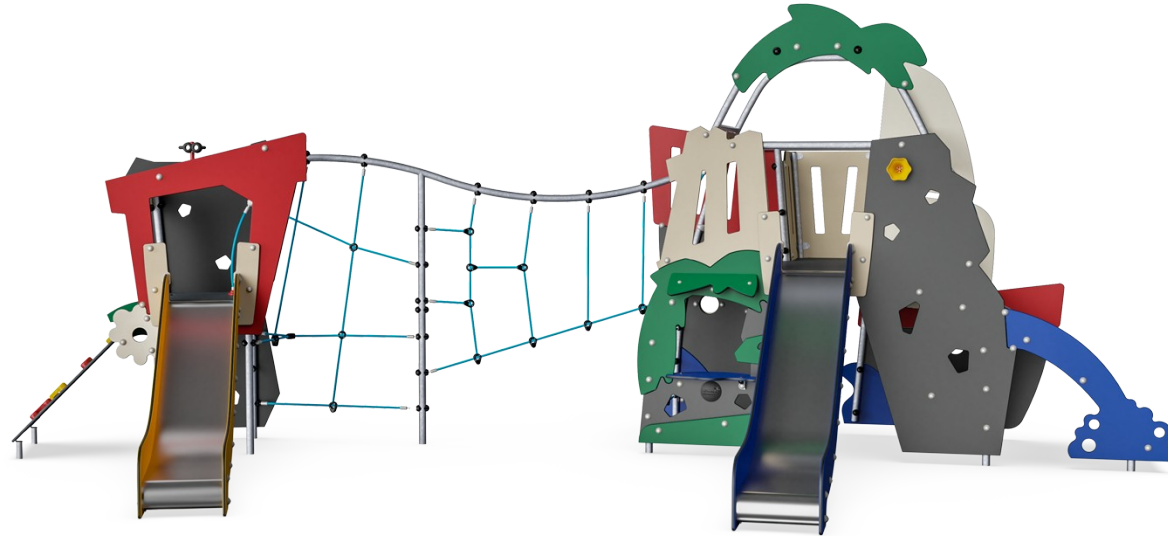

攀爬墙

身体素质：训练交叉协调能力以及腿部、手臂和手部力量。**社交情感：**对年幼的孩子来说，绳网的倾斜度让攀爬更具安全感。



攀爬网

身体素质：有助于训练跨体协调能力和肌肉力量。绳网的不对称也锻炼儿童的攀爬能力。



Balcony

社交情感：阳台鼓励儿童在此会面，或与地面上的人互动。



Den

身体素质：在开口处爬行可以训练空间意识。**社交情感：**封闭的空间适合两三个孩子一起玩要。



Binoculars

认知能力：创造了一个有形的主题，促进戏剧扮演。戏剧扮演可以很好地训练语言技巧。**创造力：**双筒望远镜可以 360 度旋转，让孩子们从新视角看世界。



滑梯

身体素质：玩滑梯可以培养空间感和平衡感。此外，在直立向下坐时，核心肌肉也能得到锻炼。**社交情感：**轮流玩耍时可激发同理心。**认知能力：**幼儿在快速滑下时可训练对空间、速度和距离的理解。

Jungle & Ocean with Net Tower

MSC6404



19 毫米 EcoCore™ 面板。EcoCore™ 是一种高度耐用、环保的材料，不仅在使用后可回收利用，而且还包含由 100 % 食品包装可循环材料制成的芯。

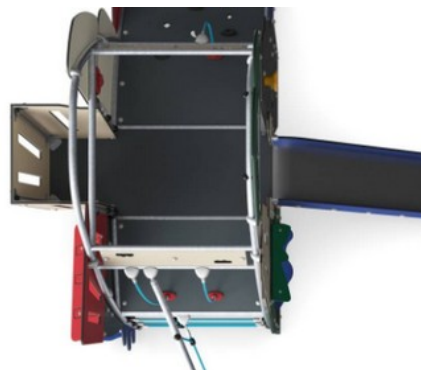

根据 EN 438-6，所有地板均由高压层压 HPL 制成，厚度为 17.8mm，表面防滑。KOMPAN HPL 具有很高的耐磨强度，可确保在所有气候下均具有较长的使用寿命。

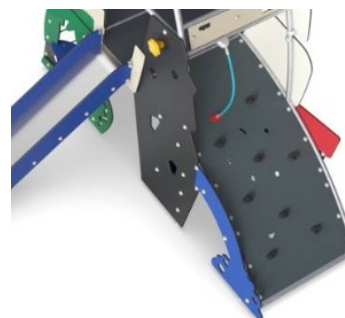

曲线攀登墙由 Ekogrip® 面板组成，该面板由 15mm 厚的聚乙烯底座和 3mm 厚的软橡胶制成，具有防滑效果。

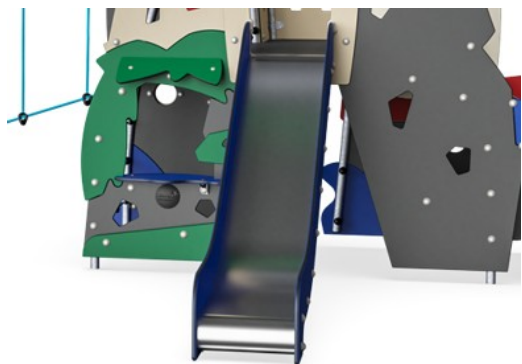

滑梯由 EcoCore™ 侧板和不锈钢滑床 t=2mm 组合而成。

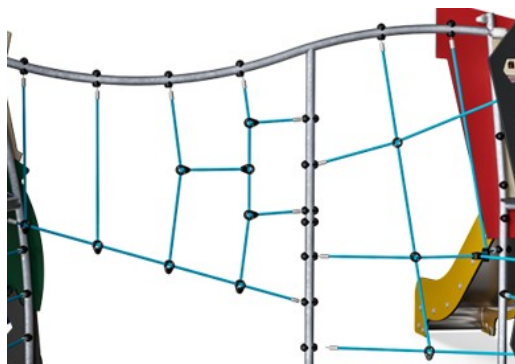

攀爬网由防紫外线的聚丙烯绳和内部的钢缆构成强化。对钢丝绳进行了感应处理，使其在钢和钢丝绳之间得到最大程度的固定，从而具有很好的耐磨性和抗撕裂性。所有的绳接头都是由 100% 可回收的 PA 材料制成。



钢表面内外均采用无铅热镀锌镀层，户外耐蚀性高，维护成本低。

产品编号 MSC640400-3717P

安装信息

最大跌落高度	193 cm
安全面积	51.1 m ²
安装总时长	31.7
开挖量	1.50 m ³
混凝土使用量	0.00 m ³
标准入地深度	90 cm
运输重量	1,037 kg
固定选项	入地 ✓ 地表 ✓

质保信息

EcoCore HDPE	终身质保
镀锌钢结构	终身质保
HPL 甲板	15 年
绳网	10 年
承保零部件	10 年



Sustainability Data

MSC6404



从原材料到成品

CO₂ 排放总量

kg CO₂e

CO₂ 排放量 / 千克

kg CO₂e/kg

回收的原料

%

MSC640400-3717P

1,795.68

2.28

57.52

这些因素采用的总体框架为环保产品声明 (EPD), 该声明可量化“产品生命周期的环保信息, 并对相同功能的产品进行对比” (ISO, 2006)。在遵循该框架的同时, 对从原材料到制造的整个产品阶段 (A1-A3) 应用生命周期评估法。

Kompan A/S

C.F. Tietgens Boulevard 32C
DK-5220 Odense SØ
Denmark



Verification of CO₂ calculation of: Themed play systems

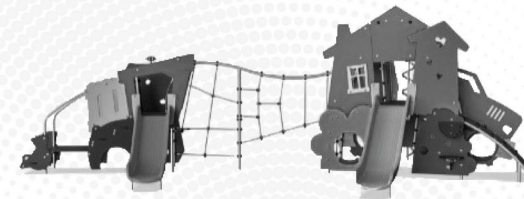

Data version no. 2023-10-05

The CO₂ calculation and data are in compliance with the principles of a carbon footprint impact according to the GHG protocol (Greenhouse Gas Protocol), Scope 3, cradle to gate related to all individual components in the product category: "Themed play systems" represented by item no.: MSC641100-3717P.

(Scope 3 emissions include emission sources in the upstream and downstream value chain).

Date: 30. October 2023 | Valid until: 30. October 2025

Verified by:

Julie Marie Vejsgaard Larsen, LCA & EPD Consultant

Verification based on report: Validation of CO₂ calculation of 9 categories of Kompan product line, version 1.0, prepared by: Bureau Veritas HSE, Denmark: Julie M. V. Larsen.

Publication date: 30. October 2023

By Bureau Veritas HSE
www.bureauveritas.dk
+45 7731 1000



Jungle & Ocean with Net Tower

MSC6404

最大跌落高度 | 总高度 | 安全区域

最大跌落高度 | 总高度

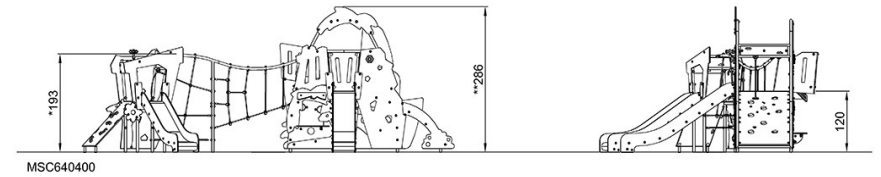
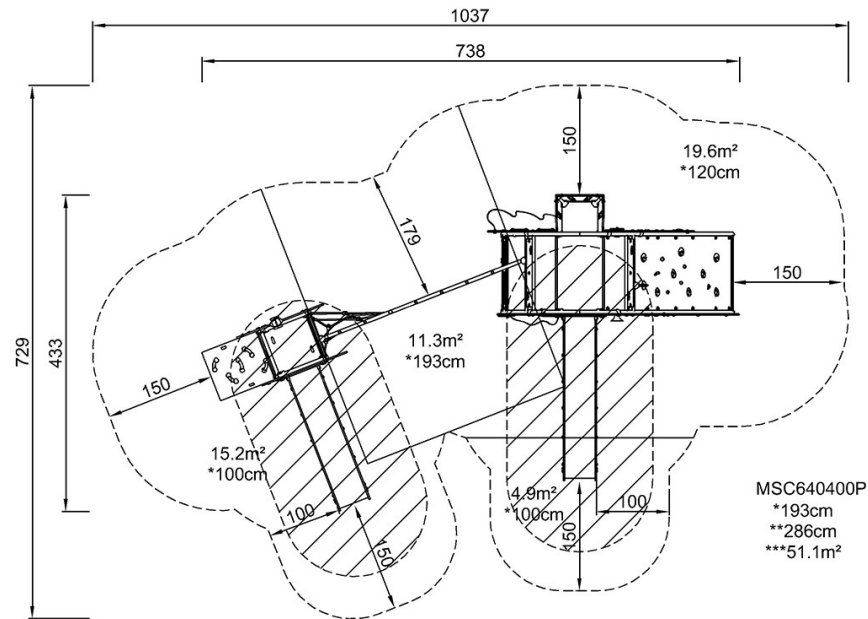

[点击查看俯视图](#)

[点击查看侧面图](#)