



Pathfinder

PCE305121



Item no. PCE305121-0603	
General Product Information	
Dimensions LxWxH	1164x889x400 cm
Age group	2+
Play capacity (users)	66
Colour options	  

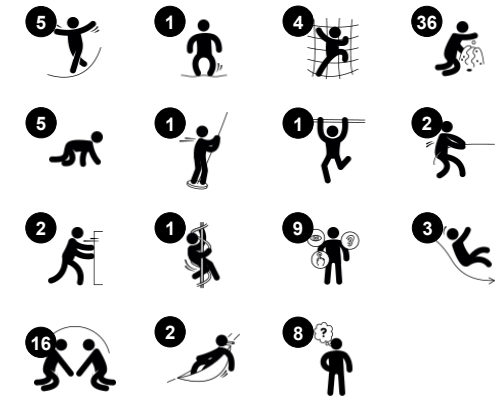

The Pathfinder ramp play unit is an immense attraction for toddlers due to its wide variety of physical, social-emotional and cognitive-creative play elements. The climbing, sliding, swaying, turning, experimenting and friendship creating opportunities make toddlers want to return again and again. The first ramp turning space offers a great variation of sensory play in

play panels, training agility as well as logical thinking skills and cooperative play. On the next turning point, additional access opportunities are added via the twisted play net, which increases layered physical stimulation and social interaction. At the end of the ramp, sensory play panels invite exploration. Varied sliding doors for co-

operative or individual entertainment makes for versatile play. The ground level activities are diverse, with talking tubes and a sand corner, inviting all to play.



Pathfinder

PCE305121



Curly climber

Physical: coordination and proprioception are supported when placing arms and legs correctly for going down. Sense of balance when rotating. Arm muscles for holding tight. **Social-Emotional:** empathy stimulated by turn-taking. **Cognitive:** logical thinking when placing arms and legs right for rotating downwards.



Crawl-through hole

Physical: the hole allows for climbing and crawling through, developing cross coordination, proprioception and spatial awareness. **Social-Emotional:** cooperation and turn-taking when passing one another. **Cognitive:** understanding space, shape and measures when seeing if the body can fit through the hole.

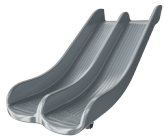

Double slide

Physical: sliding develops spatial awareness and a sense of balance. Furthermore, the core muscles are trained when sitting upright going down. **Social-Emotional:** invites socializing, supports parent-child and peer-to-peer play. **Cognitive:** young children train their understanding of space, speed and distances when sliding down quickly.



Changeable sand funnel

Social-Emotional: supports cooperation and turn-taking as children pour water or materials into the funnel. **Cognitive:** the passing of materials through funnels develops children's logical thinking, for younger children the understanding of object permanence: that materials do not vanish, but run through. **Creative:** the sand funnel can be turned, creating new directions of dispensing materials.



Accessible ramp

Physical: wheeling or being wheeled up the inclination trains spatial awareness, and in non-electric wheelchairs it trains upper body coordination and strength. Walking or crawling up an inclined surface trains cross coordination. **Cognitive:** the gradual change of height trains the understanding of space and measures for young children.



Climbing net twist

Physical: cross coordination and muscle strength when climbing and crawling through the net. Sense of balance when swaying on red plate. **Social-Emotional:** breaks are invited on the horizontal parts of the twisted net, allowing for socializing. **Cognitive:** figuring out how to position body to climb the twisted net.



Gear wheels panel

Social-Emotional: cooperation skills and turn-taking are supported when turning the gearing wheel. **Cognitive:** cause and effect understanding, and logical thinking are supported.

Pathfinder

PCE305121



The Curved ELEMENTS panels are moulded of UV stabilised recyclable PE using 33% post-consumer recycled material. With multiple options for in-build play features that also ensures a strong panel solution. Straight panels are made of KOMPAN 19mm HDPE EcoCore™ which is a highly durable, ecofriendly and recyclable material made from +95% PCM.

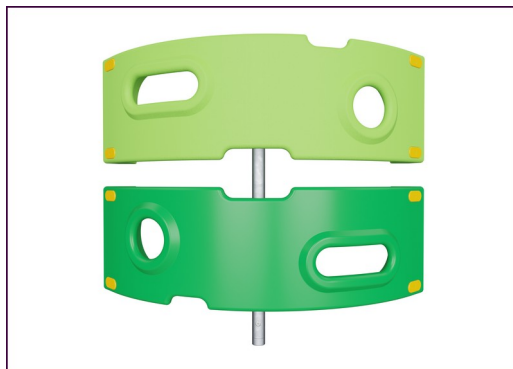

The climbing elements displayed are moulded from 33% post-consumer recycled materials in one piece, with a minimum 5mm wall thickness. The climbing elements are made of recyclable PE which has a high impact resistance across a wide temperature span which ensures vandal resistance in all locations.

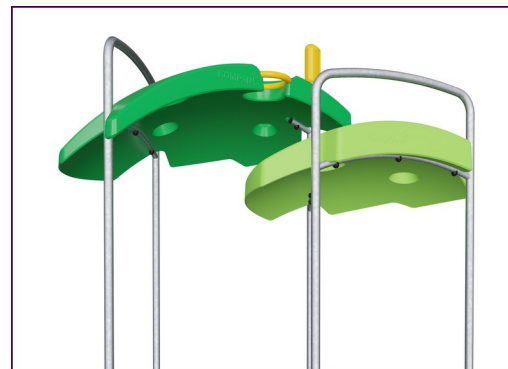

The ELEMENTS roofs are made of recyclable PE made from 33% post consumer recycled materials with a minimum wall thickness of 5 mm to ensure high durability in all climates around the world. The steel pipes are hot dip galvanised inside and outside for maximum durability.



The main posts are made of high quality pregalvanized steel with powder coated top finish. Post tops are closed with caps of UV stabilized nylon (PA6). The grey colored molded decks are made of 75% post-consumer waste PP material with a non-skid pattern and texture surface. All decks are supported by unique designed low-carbon aluminum profiles with multiple attachment options.



ELEMENTS rubber membranes are conveyer belt made of layers of rubber mixed of natural rubber and SBR rubber, and embedded with layers of armouring made of woven PE and PA. The thickness 8mm ensures high durability in any environment.

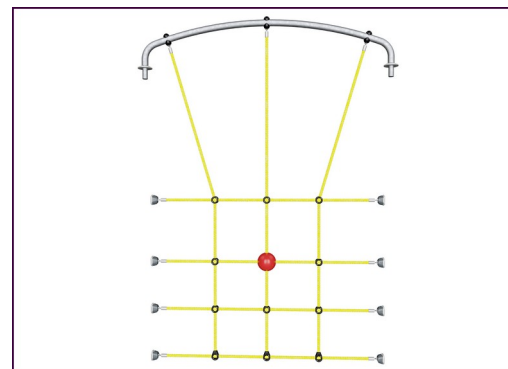

ELEMENTS ropes has six-stranded steel wires and a steel wire core. Each strand is tightly wrapped with PES yarn, which is made from +95% post consumer materials. The yarn is then melted onto each individual strand making the ropes highly wear- and vandalism-resistant.

Item no. PCE305121-0603

Installation Information

Max. fall height	204 cm
Safety surfacing area	104.0 m ²
Total installation time	61.7
Excavation volume	1.73 m ³
Concrete volume	0.25 m ³
Footing depth (standard)	80 cm
Shipment weight	2,229 kg
Anchoring options	Surface ✓ In-ground ✓

Warranty Information

Curved panels	10 years
EcoCore HDPE	Lifetime
Membrane	2 years
Post	10 years
Spare parts guaranteed	10 years



Sustainability Data

PCE305121



Cradle to Gate A1-A3	Total CO ₂ emission	CO ₂ e/kg	Recycled materials
	kg CO ₂ e	kg CO ₂ e/kg	%
PCE305121-0603	4,566.98	2.70	41.21

The overall framework applied for these factors is the Environmental Product Declaration (EPD), which quantifies "environmental information on the life cycle of a product and enable comparisons between products fulfilling the same function" (ISO, 2006). This follows the structure and applies a Life-Cycle Assessment approach to the entire Product stage from raw material through manufacturing (A1-A3))

Kompan A/S
 C.F. Tietgens Boulevard 32C
 DK-5220 Odense SØ
 Denmark



Verification of CO₂ calculation of: Play systems



Data version no. 2023-10-05

The CO₂ calculation and data are in compliance with the principles of a carbon footprint impact according to the GHG protocol (Greenhouse Gas Protocol), Scope 3, cradle to gate related to all individual components in the product category: "Play systems" represented by item no.: PCM200321-0950.

(Scope 3 emissions include emission sources in the upstream and downstream value chain).

Date: 30. October 2023 | Valid until: 30. October 2025

Verified by:

Julie Marie Vejsgaard Larsen, LCA & EPD Consultant

Verification based on report: Validation of CO₂ calculation of 9 categories of Kompan product line, version 1.0, prepared by: Bureau Veritas HSE, Denmark: Julie M. V. Larsen.

Publication date: 30. October 2023

By Bureau Veritas HSE
 www.bureauveritas.dk
 +45 7731 1000



Pathfinder

PCE305121

* Max fall height | ** Total height | *** Safety surfacing area

* Max fall height | ** Total height

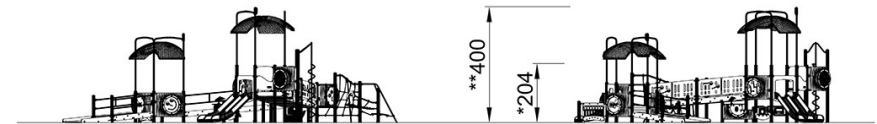
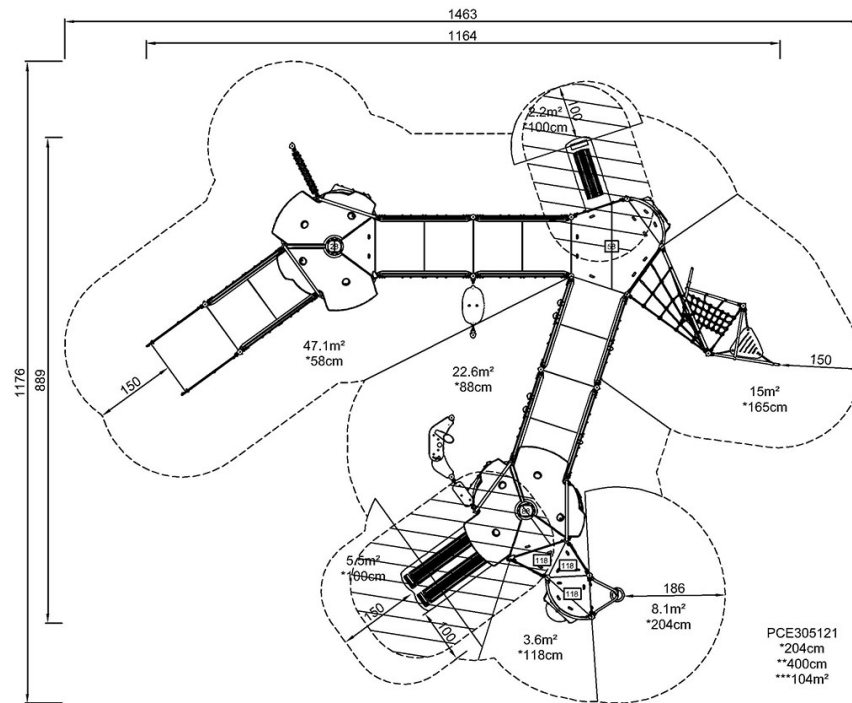

PCE305121

[Click to see TOP VIEW](#)

[Click to see SIDE VIEW](#)