

# Draaimolen met stangen

KPL115

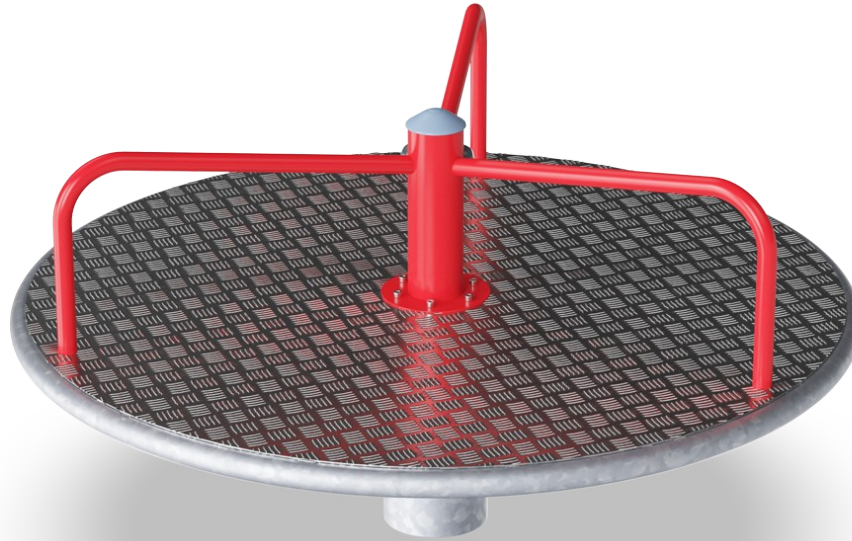

Item nummer KPL115-0501

## Algemene Product Informatie

Afmetingen LxBxH	155x155x81 cm
Leeftijdsgroep	4+
Speelcapaciteit	10
Kleuropties	  

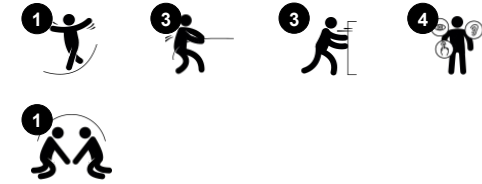

Kinderen kunnen niet genoeg krijgen van de sensatie van snelheid en draaien. Ons assortiment bevat zowel traditionele carrouzels als innovatieve draaitoestellen.

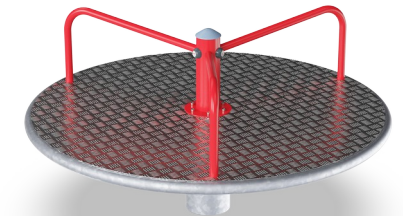

# Draaimolen met stangen

KPL115

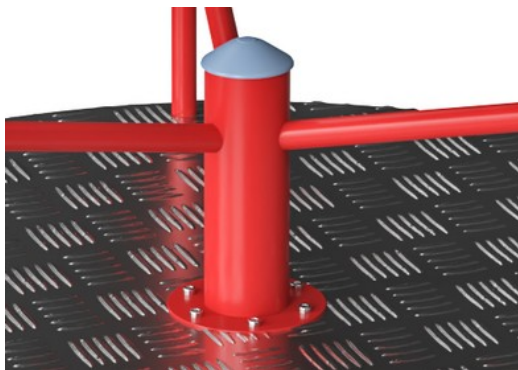

De stalen oppervlakken zijn binnen en buiten thermisch verzinkt met loodvrij zink en met een gepoedercoate bovenlaag. Het verzinken heeft een uitstekende corrosiebestendigheid in de buitenlucht en vereist weinig onderhoud.

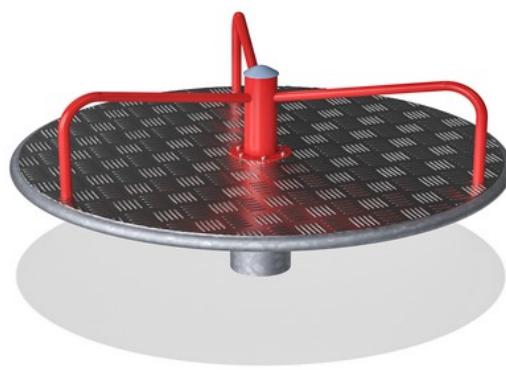

Zwaar uitgevoerd lagersysteem met twee enkele rij diepgroefkogellagers van hoge kwaliteit met rubberen afdichtingen. De volledig gesloten lagerconstructie is levenslang gesmeerd en bevindt zich boven de grond.

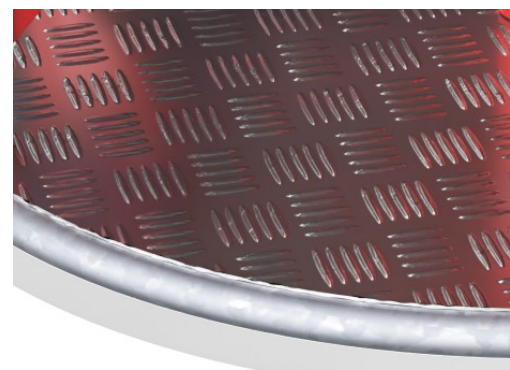

Vloerplaat van 3mm dik hoogwaardig aluminium met 2mm dik antislipprofiel. Deze aluminium plaat zorgt voor veilig spel voor alle gebruikers en vereist weinig onderhoud.

Item nummer KPL115-0501

## Installatie informatie

Max. valhoogte	100 cm
Veiligheidszone	24,2 m <sup>2</sup>
Totale installatietijd	2,4
Graafwerk (vol.)	0,45 m <sup>3</sup>
Benodigd beton	0,40 m <sup>3</sup>
Verankeringsdiepte	80 cm
Verzendingsgewicht	148 kg
Verankeringsopties	In-ground ✓

## Garantie informatie

Aluminium vloer	15 jaar
Lagerhuisconstructie	5 jaar
Gegalvaniseerd staal	Levenslang
Gegarandeerde reserveonderdelen	10 jaar



# Sustainability Data

KPL115

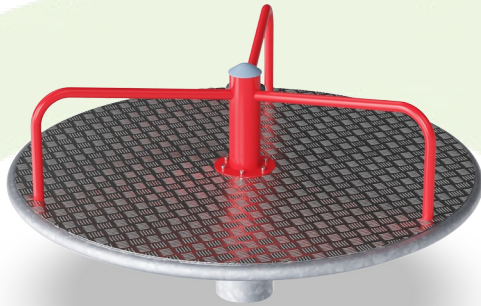

Cradle to Gate A1-A3	Total CO <sub>2</sub> emission	CO <sub>2</sub> e/kg	Recycled materials
	kg CO <sub>2</sub> e	kg CO <sub>2</sub> e/kg	%
<b>KPL115-0501</b>	421,11	3,52	43,94

The overall framework applied for these factors is the Environmental Product Declaration (EPD), which quantifies "environmental information on the life cycle of a product and enable comparisons between products fulfilling the same function" (ISO, 2006). This follows the structure and applies a Life-Cycle Assessment approach to the entire Product stage from raw material through manufacturing (A1-A3))

**Kompan A/S**  
C.F. Tietgens Boulevard 32C  
DK-5220 Odense SØ  
Denmark



## Verification of CO<sub>2</sub> calculation of: Freestanding play equipment



Data version no. 2023-10-05

The CO<sub>2</sub> calculation and data are in compliance with the principles of a carbon footprint impact according to the GHG protocol (Greenhouse Gas Protocol), Scope 3, cradle to gate related to all individual components in the product category: "Freestanding play equipment" represented by item no.: GXY916012-3417.

(Scope 3 emissions include emission sources in the upstream and downstream value chain).

**Date: 30. October 2023 | Valid until: 30. October 2025**

Verified by:

Julie Marie Vejsgaard Larsen, LCA & EPD Consultant

Verification based on report: Validation of CO<sub>2</sub> calculation of 9 categories of Kompan product line, version 1.0, prepared by: Bureau Veritas HSE, Denmark: Julie M. V. Larsen.

**Publication date: 30. October 2023**

By Bureau Veritas HSE  
www.bureauveritas.dk  
+45 7731 1000



# Draaimolen met stangen

KPL115

Max. valhoogte | Totale Hoogte | Veiligheidszone

Max. valhoogte | Totale Hoogte

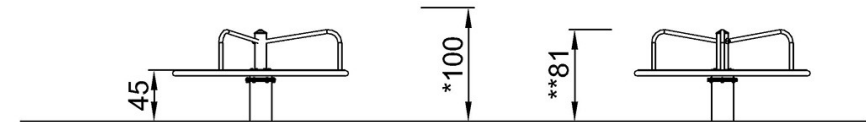
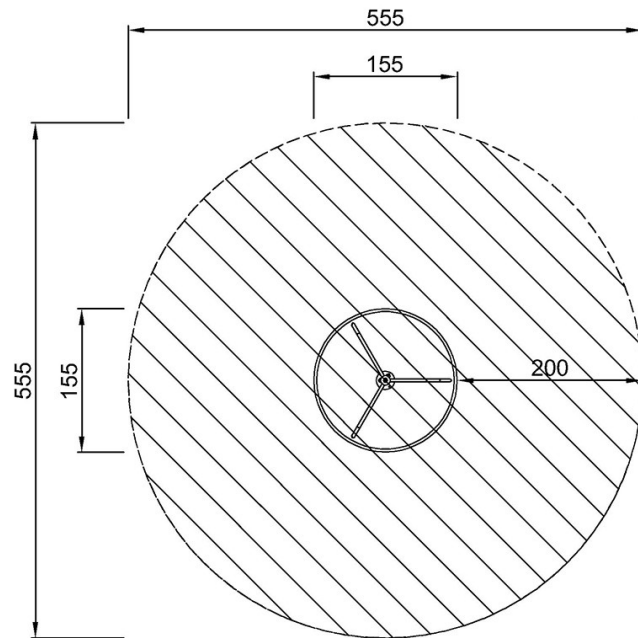

KPL115  
\*100cm  
\*\*81cm  
\*\*\*24.2m<sup>2</sup>

[Bekijk BOVENAANZICHT](#)

[Bekijk ZIJAAANZICHT](#)