

# Large Rope Play Tower

COR29600

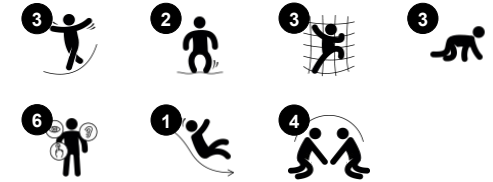

Item no. COR296001-1104	
<b>General Product Information</b>	
Dimensions LxWxH	918x862x730 cm
Age group	5+
Play capacity (users)	33
Color options	



The Large Rope Play Tower is a remarkable landmark that sends an impactful signal of play to all users. A swaying climb up to the first platform of the play tower calls for a break. The climb up to the top platform rewards the children with great viewpoint, and a thrilling ride back down the slide to the ground. A lot of children can play in the structure, for a long

time, and the various ways of entering the structure will sustain their interest in the play. Climbing or swaying in the Large Rope Play Tower is challenging. It trains the motor skills ABC's: Agility, Balance and coordination. The major muscle groups get used when children climb here. The feeling of height and the transparency of the nets when standing on

them up high adds thrill and additionally trains important social-emotional skills such as self regulation and courage.

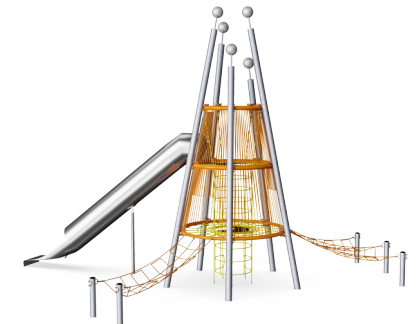

# Large Rope Play Tower

COR29600



Ropes of UV-stabilized PES rope strands with inner steel cable reinforcement. The polyester yarn is made from +95% post-consumer materials and is inductively melted onto each strand. The ropes are highly wear-and vandalism-resistant and can be replaced at site if needed.



Corocord 'S' clamps are used as universal connections in Corocord products. 8mm stainless steel rods with rounded edges are pressed around the ropes with a special hydraulic press, making them the ideal connector: safe, durable and vandalism-proof, all while allowing the typical movement of rope play structures.



The aluminium swages of the net are double conical with rounded ends and are as small as safety allows. The overall net design aims at keeping metal parts within the net to an absolute minimum, both in size and number, in order to provide the best possible rope climbing experience.

Item no. COR296001-1104	
Installation Information	
Max. fall height	150 cm
Safety surfacing area	72.3 m <sup>2</sup>
Total installation time	51.5
Excavation volume	18.69 m <sup>3</sup>
Concrete volume	11.87 m <sup>3</sup>
Footing depth (standard)	110 cm
Shipment weight	3,498 kg
Anchoring options	In-ground ✓



Corocord membranes consist of friction-proof rubberized material of conveyor belt quality with excellent UV resistance. Tested and compliant with REACH requirements for PAH. Embedded is a four-layered armoring made of woven polyester. The armoring and the two surface layers result in a total thickness of 7.5 mm.



The metal parts are made of high quality steel, hot dip galvanised inside and outside with leadfree zinc. On the outside, there is an additional layer of powder coating. This ensures both excellent corrosion resistance and colourful design expression.

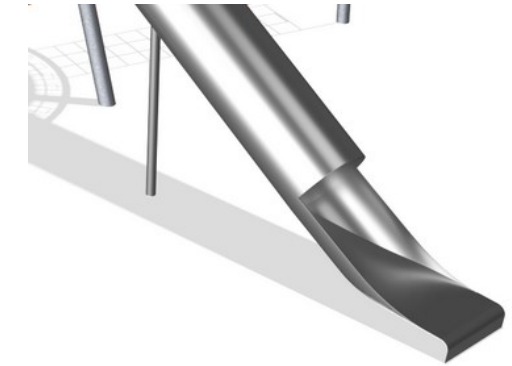

The stainless steel components are made of high quality stainless steel in compliance with global playground standards. The steel is glass blasted after manufacturing to ensure a smooth gliding surface.



# Sustainability Data

COR29600

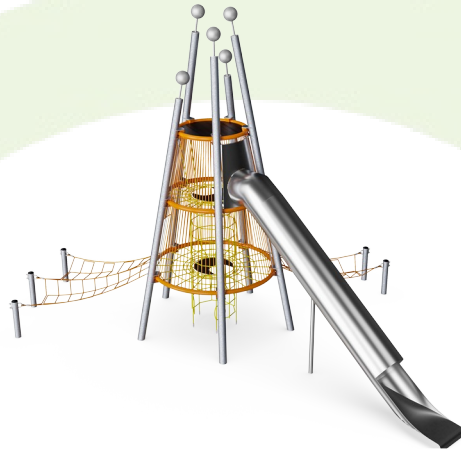

Cradle to Gate A1-A3	Total CO <sub>2</sub> emission	CO <sub>2</sub> e/kg	Recycled materials
	kg CO <sub>2</sub> e	kg CO <sub>2</sub> e/kg	%
<b>COR296001-1104</b>	7,619.90	2.98	48.60

The overall framework applied for these factors is the Environmental Product Declaration (EPD), which quantifies "environmental information on the life cycle of a product and enable comparisons between products fulfilling the same function" (ISO, 2006). This follows the structure and applies a Life-Cycle Assessment approach to the entire Product stage from raw material through manufacturing (A1-A3))

**Kompan A/S**  
 C.F. Tietgens Boulevard 32C  
 DK-5220 Odense SØ  
 Denmark



## Verification of CO<sub>2</sub> calculation of: Corocord

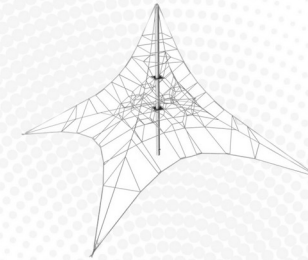

Data version no. 2023-10-05

The CO<sub>2</sub> calculation and data are in compliance with the principles of a carbon footprint impact according to the GHG protocol (Greenhouse Gas Protocol), Scope 3, cradle to gate related to all individual components in the product category: "Corocord" represented by item no.: COR314011-1101.

(Scope 3 emissions include emission sources in the upstream and downstream value chain).

**Date: 30. October 2023 | Valid until: 30. October 2025**

**Verified by:**

Julie Marie Vejsgaard Larsen, LCA & EPD Consultant

Verification based on report: Validation of CO<sub>2</sub> calculation of 9 categories of Kompan product line, version 1.0, prepared by: Bureau Veritas HSE, Denmark: Julie M. V. Larsen.

**Publication date: 30. October 2023**

**By Bureau Veritas HSE**  
 www.bureauveritas.dk  
 +45 7731 1000



# Large Rope Play Tower

COR29600

\* Max fall height | \*\* Total height | \*\*\* Safety surfacing area

\* Max fall height | \*\* Total height

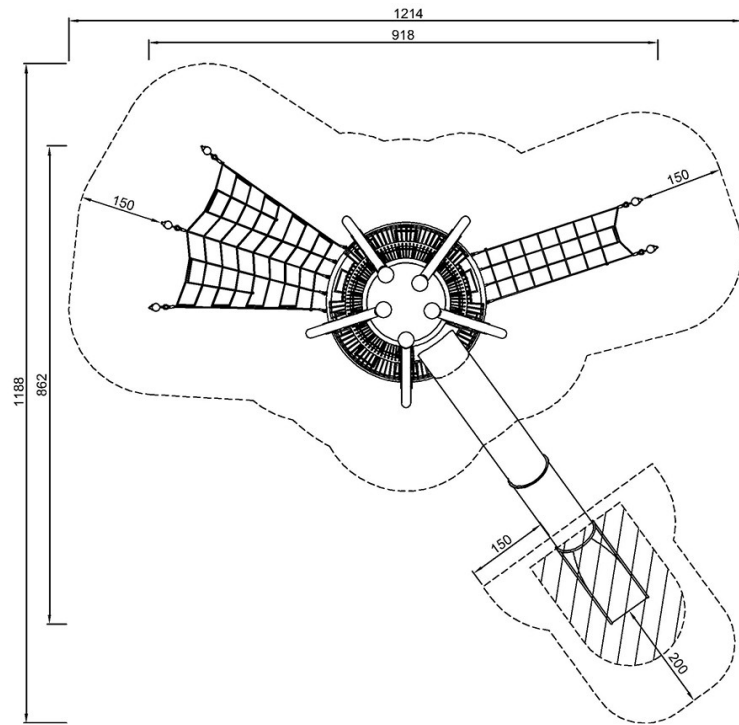

COR296001  
\*150cm  
\*\*730cm  
\*\*\*72.3m<sup>2</sup>

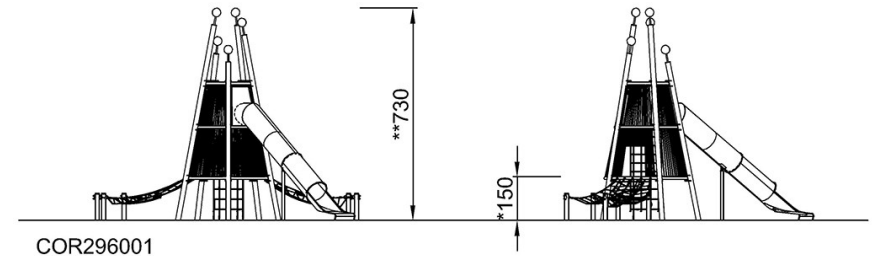

COR296001

[Click to see TOP VIEW](#)

[Click to see SIDE VIEW](#)