

# Wave

COR16500

Item no. COR165001-0803	
<b>General Product Information</b>	
Dimensions LxWxH	1967x455x280 cm
Age group	5 - 12
Play capacity (users)	55
Colour options	

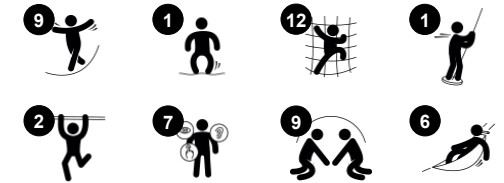
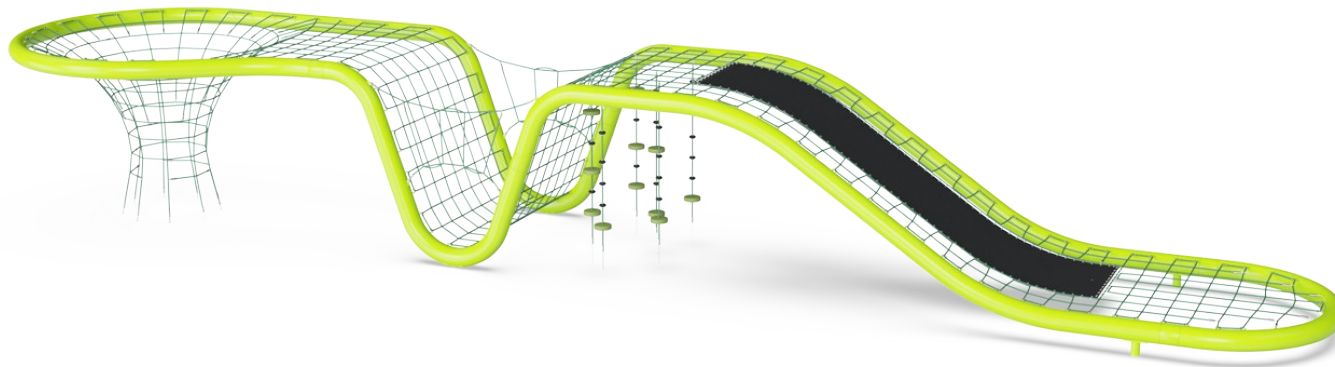

The Wave puts thrill in motion for older children and their adult companions alike. Families and neighbours will come together to ride the waves, challenging their bodies and exciting their minds. The structure is carefully designed to inspire a range of movements and to encourage people to play in a variety of ways each time they come to the playground. This

helps to sustain play and add incredible value to the playground experience. When children climb the structure, they are strengthening their physical skills, especially their agility, balance, and Coordination, the ABC's of fitness. At the same time, this structure provides for the perfect social space that will encourage children to meet friends, strengthening social

bonds. This wave structure also supports imagination and fantasy play that nourishes children's well-being. (Design: Annabau)



# Wave

COR16500



## Vertical climbing funnel

**Physical:** develops cross coordination and trains major muscles when climbing up or down. **Social-Emotional:** socializing and friendly competition when climbing up and down with friends.

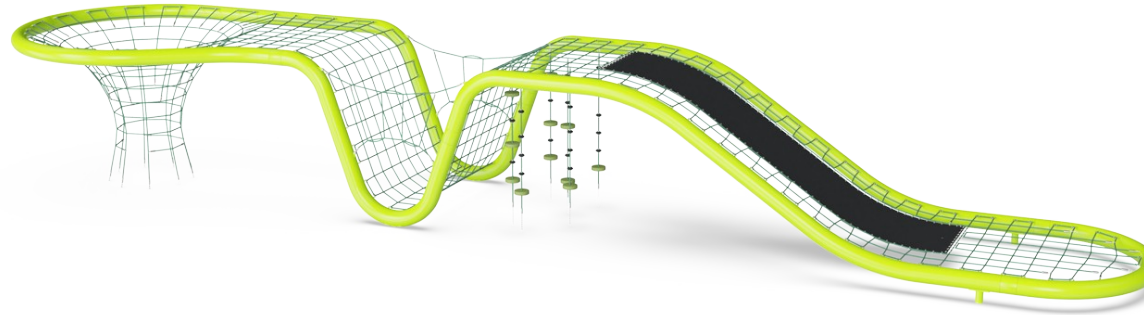

## Membrane glide

**Physical:** sense of balance and space when gliding down, cross coordination and major muscle groups when climbing up the membrane. **Social-Emotional:** cooperation and consideration of others, turn-taking.



## Horizontal net area

**Physical:** cross coordination when crawling across. **Social-Emotional:** thrill when looking down from up high. Socializing with friends seated on the net.



## Climbing valley w. tight rope sides

**Physical:** varied climbing up and down and balancing across tight ropes with vertical support ropes train balance, coordination and muscles intensely. **Social-Emotional:** cooperation and consideration when balancing and climbing with others. The parallel tight ropes and vertical net walls inspire positive competition.



## Swaying rope area

**Physical:** agility, balance and cross coordination when climbing from one to the next seat in the swaying ropes. Proprioception and muscles when climbing upwards on the rope. **Social-Emotional:** cooperation with friends, breaks with friends. **Cognitive:** spurs rules games such as the-ground-is-lava.

# Wave

COR16500



Ropes of UV-stabilized PES rope strands with inner steel cable reinforcement. The polyester yarn is made from +95% post-consumer materials and is inductively melted onto each strand. The ropes are highly wear-and vandalism-resistant and can be replaced at site if needed.



Corocord 'S' clamps are used as universal connections in Corocord products. 8mm stainless steel rods with rounded edges are pressed around the ropes with a special hydraulic press, making them the ideal connector: safe, durable and vandalism-proof, all while allowing the typical movement of rope play structures.



The steel surface of these bended steel pipes are wet painted with one basic layer and one top layer of lead free colour material. The paint has excellent corrosion resistance and can be easily maintained.



Corocord membranes consist of friction-proof rubberized material of conveyor belt quality with excellent UV resistance. Tested and compliant with REACH requirements for PAH. Embedded is a four-layered armouring made of woven polyester. The armouring and the two surface layers result in a total thickness of 7.5 mm.



Fully coloured EPDM rubber discs with smooth surface. The moulded EPDM surrounds a hot dip galvanised steel core that ensures both the stability of the discs and durable fixation to the rope.

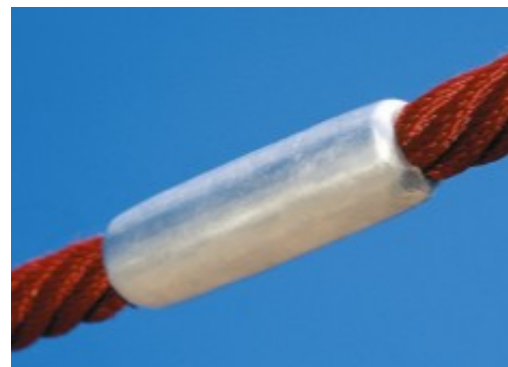

The aluminium swages of the net are double conical with rounded ends and are as small as safety allows. The overall net design aims at keeping metal parts within the net to an absolute minimum, both in size and number, in order to provide the best possible rope climbing experience.

Item no. COR165001-0803

### Installation Information

Max. fall height	0 cm
Safety surfacing area	0.0 m <sup>2</sup>
Total installation time	103.0
Excavation volume	6.77 m <sup>3</sup>
Concrete volume	3.38 m <sup>3</sup>
Footing depth (standard)	80 cm
Shipment weight	4,749 kg
Anchoring options	In-ground ✓

### Warranty Information

Aluminium clamps	10 years
Corocord rope	10 years
Membrane	2 years
S-Clamps	10 years
Spare parts guaranteed	10 years

Elevated activities 0	Accessible elevated activities	Accessible ground level activities	Accessible ground level play types
Present	0	1	1
Required	0	1	1

**CSA  
Z614**  
compliant

# Sustainability Data

COR16500

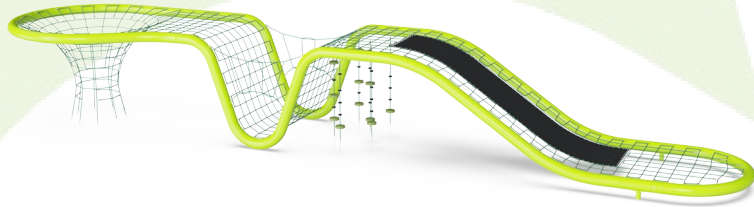

Cradle to Gate A1-A3	Total CO <sub>2</sub> emission	CO <sub>2</sub> e/kg	Recycled materials
	kg CO <sub>2</sub> e	kg CO <sub>2</sub> e/kg	%
<b>COR165001-0803</b>	12,433.40	2.67	49.00

The overall framework applied for these factors is the Environmental Product Declaration (EPD), which quantifies "environmental information on the life cycle of a product and enable comparisons between products fulfilling the same function" (ISO, 2006). This follows the structure and applies a Life-Cycle Assessment approach to the entire Product stage from raw material through manufacturing (A1-A3))

**Kompan A/S**  
 C.F. Tietgens Boulevard 32C  
 DK-5220 Odense SØ  
 Denmark



## Verification of CO<sub>2</sub> calculation of: Corocord



Data version no. 2023-10-05

The CO<sub>2</sub> calculation and data are in compliance with the principles of a carbon footprint impact according to the GHG protocol (Greenhouse Gas Protocol), Scope 3, cradle to gate related to all individual components in the product category: "Corocord" represented by item no.: COR314011-1101.

(Scope 3 emissions include emission sources in the upstream and downstream value chain).

**Date: 30. October 2023 | Valid until: 30. October 2025**

Verified by:

Julie Marie Vejsgaard Larsen, LCA & EPD Consultant

Verification based on report: Validation of CO<sub>2</sub> calculation of 9 categories of Kompan product line, version 1.0, prepared by: Bureau Veritas HSE, Denmark: Julie M. V. Larsen.

**Publication date: 30. October 2023**

By Bureau Veritas HSE  
 www.bureauveritas.dk  
 +45 7731 1000





# Wave

COR16500

\* Max fall height | \*\* Total height | \*\*\* Safety surfacing area

\* Max fall height | \*\* Total height

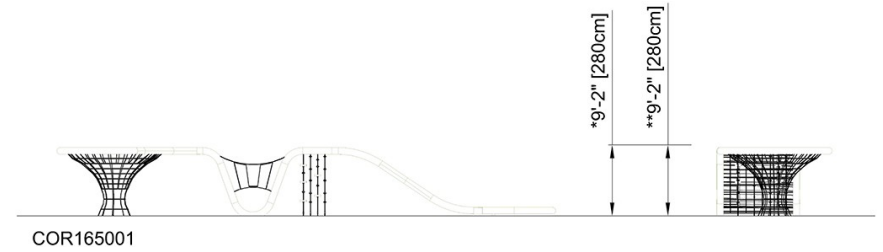
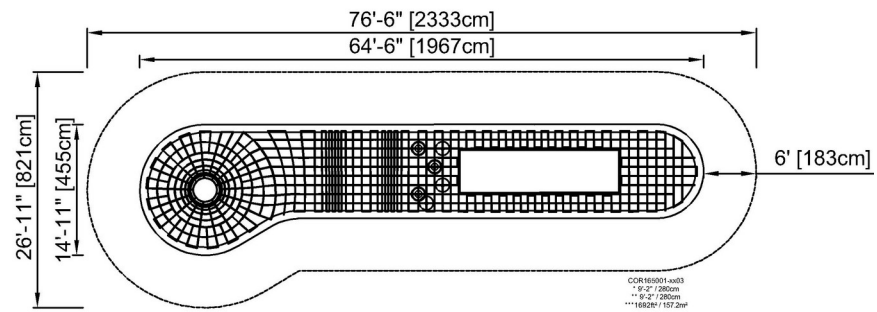

[Click to see TOP VIEW](#)

[Click to see SIDE VIEW](#)