

Slide Steel, Teal

BASIC353



Sliding is a favorite playground activity that attracts children to being active and playful in a thrilling way. This sturdy slide will delight children and encourage them to be brave and enthusiastic on the playground, for hours of imaginative and active play. When children slide they train their core muscles, sitting upright while sliding down. This stimulates their

trunk stability, important for avoiding back and neck pains – a growing problem in children due to sedentary lifestyles. Sliding additionally train the child's sense of balance and spatial understanding. These skills are important in navigating the world securely. They are the fundament of all motor skills and thus a fundament in physical confidence in the child.

The steps of the stair are great for little knees and hands with their PUR cover. adding a feeling of confidence to the climb.

Item no. BASIC353-3418P	
General Product Information	
Dimensions LxWxH	65x319x198 cm
Age group	2+
Play capacity (users)	2
Color options	

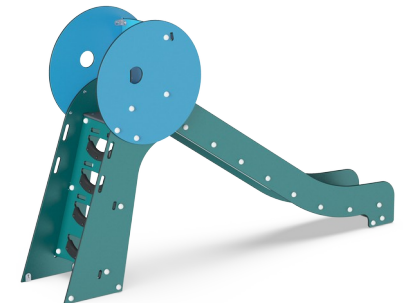
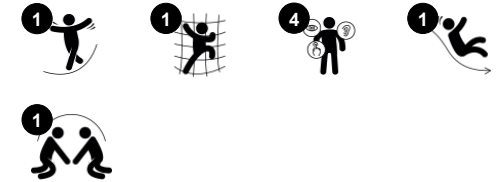

Slide Steel, Teal

BASIC353

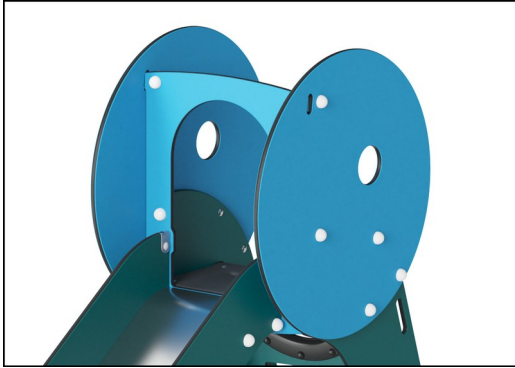

Panels of 19mm EcoCore™. EcoCore™ is a highly durable, eco friendly material, which is not only recyclable after use, but also consists of material produced from +95% recycled post consumer material from food packing waste.

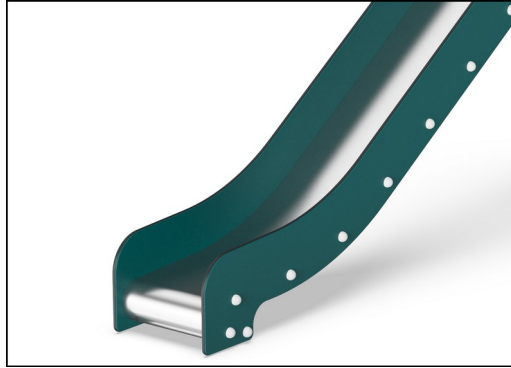

The stainless steel components are made of high quality stainless steel in compliance with global playground standards. The steel is glass blasted after manufacturing to ensure a smooth gliding surface.

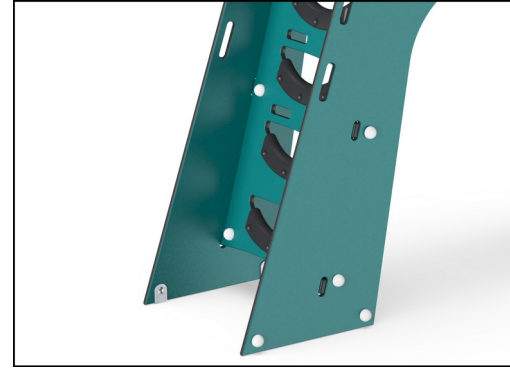

Steps are made of PUR. It retains its properties in the temperature range of -30°C to 60°C. Material is UV stabilised.

Item no. BASIC353-3418P

Installation Information

Max. fall height	120 cm
Safety surfacing area	18.8 m ²
Total installation time	5.9
Excavation volume	0.18 m ³
Concrete volume	0.00 m ³
Footing depth (standard)	60 cm
Shipment weight	153 kg
Anchoring options	In-ground ✓ Surface ✓



KOMPAN GreenLine versions are designed with ultimate environmentally friendly materials with lowest possible CO2e emission factor such as EcoCore™ panels of +95% post consumer recycled ocean waste.



Sustainability Data

BASIC353



Cradle to Gate A1-A3	Total CO ₂ emission	CO ₂ e/kg	Recycled materials
	kg CO ₂ e	kg CO ₂ e/kg	%
BASIC353-3418P	195.90	1.61	77.00

The overall framework applied for these factors is the Environmental Product Declaration (EPD), which quantifies "environmental information on the life cycle of a product and enable comparisons between products fulfilling the same function" (ISO, 2006). This follows the structure and applies a Life-Cycle Assessment approach to the entire Product stage from raw material through manufacturing (A1-A3))

Kompan A/S
C.F. Tietgens Boulevard 32C
DK-5220 Odense SØ
Denmark



Verification of CO₂ calculation of: Freestanding play equipment



Data version no. 2023-10-05

The CO₂ calculation and data are in compliance with the principles of a carbon footprint impact according to the GHG protocol (Greenhouse Gas Protocol), Scope 3, cradle to gate related to all individual components in the product category: "Freestanding play equipment" represented by item no.: GXY916012-3417.

(Scope 3 emissions include emission sources in the upstream and downstream value chain).

Date: 30. October 2023 | Valid until: 30. October 2025

Verified by:

Julie Marie Vejsgaard Larsen, LCA & EPD Consultant

Verification based on report: Validation of CO₂ calculation of 9 categories of Kompan product line, version 1.0, prepared by: Bureau Veritas HSE, Denmark: Julie M. V. Larsen.

Publication date: 30. October 2023

By Bureau Veritas HSE
www.bureauveritas.dk
+45 7731 1000



Slide Steel, Teal

BASIC353

* Max fall height | ** Total height | *** Safety surfacing area

* Max fall height | ** Total height

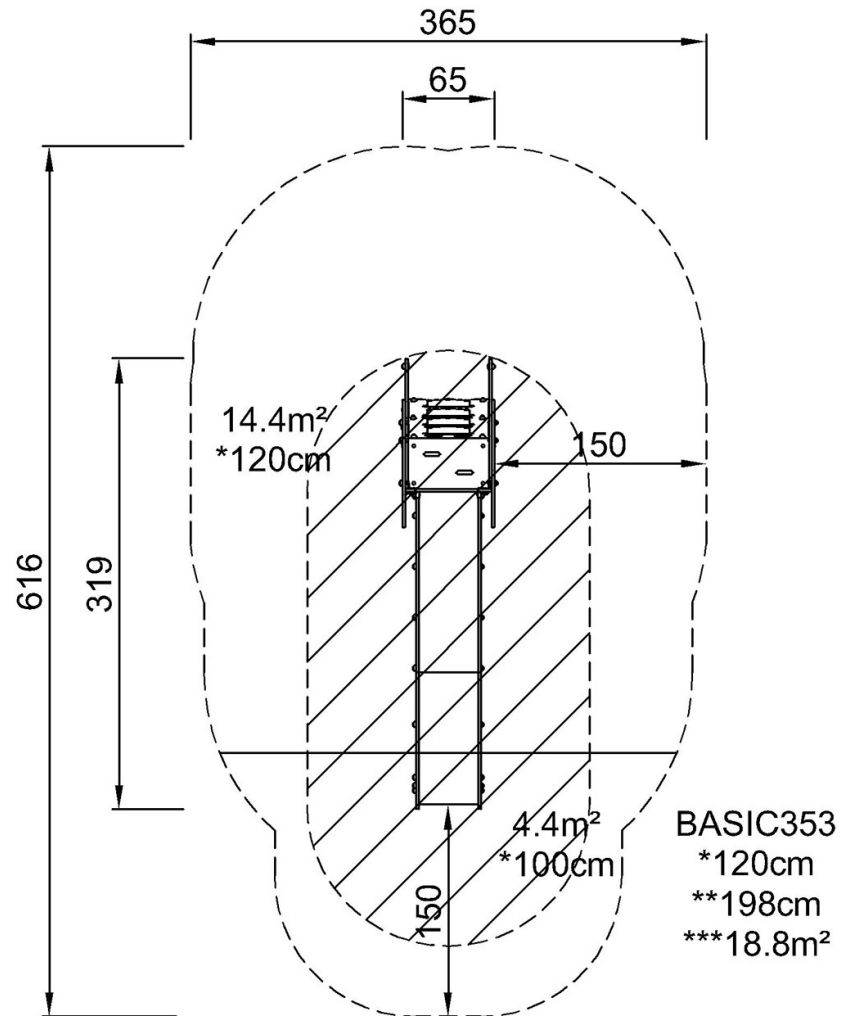

[Click to see TOP VIEW](#)

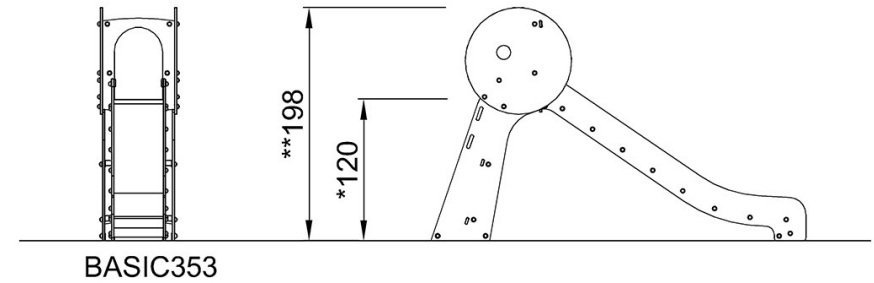

[Click to see SIDE VIEW](#)