

# Play Tower with Bars

PCM112121

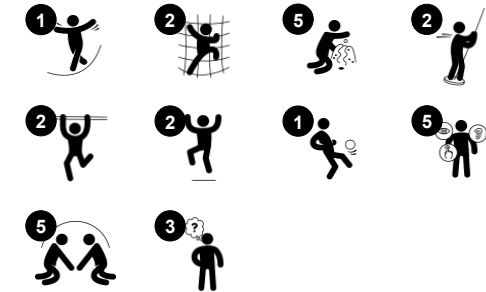

产品编号 PCM112121-0905	
产品信息概览	
长宽高尺寸	316x360x230 cm
适用年龄段	4+
容纳人数	11
颜色选择	



This play tower with bannister bars and climbing wall attracts children with its varied play offering. Varied climbing, crawling, gliding and balancing make children want to come back again and again. The graduated challenges allows for varied abilities and a wide age span in users. Under the deck there is a nice point for taking a rest and socialising with

tic-tac-toe. Climbing helps to develop cross-coordination skills. This enhances a child's ability to use both sides of their brain, and supports the ability of reading. The Fireman's Pole and Banister bars allow for bravehearts to glide down, training their sense of balance and space while having fun. These skills are fundamental in navigating the body through life

confidently and safely.

# Play Tower with Bars

PCM112121



## Banister bars

**身体素质：**跳下来时，身体的协调性、手臂和核心肌肉都会得到发展。落地运动可增强骨密度，为童年生活做好准备。**社交情感：**训练轮流意识和风险意识。



## Fireman's pole

**身体素质：**当下降时，协调得到支持，同时也锻炼了手臂和核心肌肉。着地时会增强骨密度，这对于儿童早期生活中的骨骼建设至关重要。**社交情感：**训练轮流意识和风险意识。



## Climbing wall

**身体素质：**培养儿童攀爬时的交叉协调能力、手眼协调能力和肌肉力量。**社交情感：**双面攀爬活动需要合作意识。

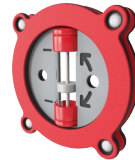

## Timer

**社交情感：**teams can each have a button to measure rounds, wins etc. The buttons support cooperation and teamwork. **认知能力：**counting and registering support thinking skills such as logical thinking and sequencing. **创造力：**children can leave their mark, placing the timer in different positions.

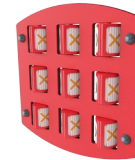

## Tic-tac-toe panel

**社交情感：**激发出相互交流和轮流发言的技能。**认知能力：**培养规则理解能力和战略思维。**创造力：**当滚轮留在新位置时会留下痕迹。

# Play Tower with Bars

PCM112121

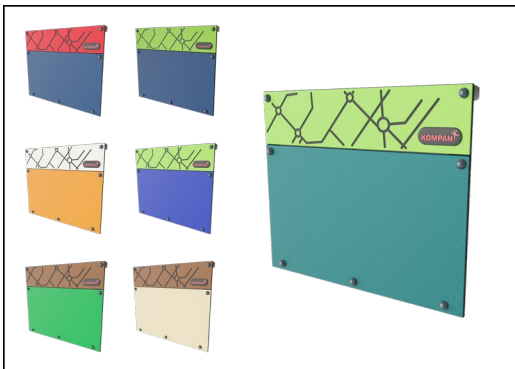

19 毫米 EcoCore™ 面板。EcoCore™ 是一种高度耐用、环保的材料，不仅在使用后可回收利用，而且还包含由 100 % 食品包装可循环材料制成的芯。



具有热镀锌钢脚的主立柱有不同的材料可供选择：压力浸渍松木立柱；在内外外部进行了预镀锌处理，顶部涂有粉末涂层的钢柱；无铅铝，表面彩色阳极氧化处理；环保产品 TexMade 立柱，100% 消费后再生的 PE 和纺织废料制成。



所有平台底板均由独特设计的低碳铝型材支撑，并具有多种加配选择。灰色模制平台底板由 75% 消费后的海洋可循环 PP 材料制成，具有防滑图案和表面纹理。



载玻片可以选择六种不同的颜色和树形材料：直的或弯曲的一体式成型 PE 载玻片。结合 EcoCore™ 侧面和不锈钢。全不锈钢一体式设计，更多防破坏解决方案。

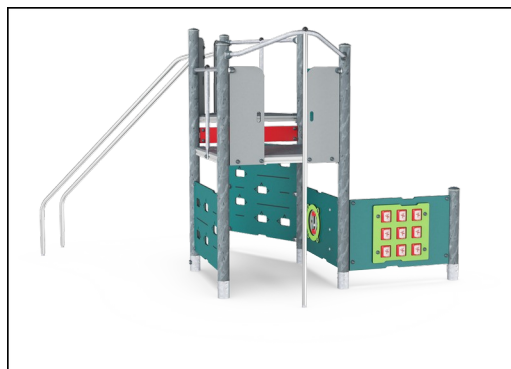

KOMPAN 环保系列产品采用终极环保材料设计，具有最低可能性的二氧化碳排放当量系数。TexMade 立柱，100% 消费后的海洋可循环材料制成的 EcoCore™ 面板和模制 PP 平台底板。

产品编号 PCM112121-0905

## 安装信息

最大跌落高度	209 cm
安全面积	26.6 m <sup>2</sup>
安装总时长	11.3
开挖量	0.73 m <sup>3</sup>
混凝土使用量	0.05 m <sup>3</sup>
标准入地深度	90 cm
运输重量	361 kg
固定选项	地表 ✓ 入地 ✓

## 质保信息

EcoCore HDPE	终身质保
活动部件	2 年
立柱	10 年
PP 板	10 年
承保零部件	10 年



# Sustainability Data

PCM112121



## 从原材料到成品

CO<sub>2</sub> 排放总量

kg CO<sub>2</sub>e

CO<sub>2</sub> 排放量 / 千克

kg CO<sub>2</sub>e/kg

回收的原料

%

从原材料到成品	CO <sub>2</sub> 排放总量 kg CO <sub>2</sub> e	CO <sub>2</sub> 排放量 / 千克 kg CO <sub>2</sub> e/kg	回收的原料 %
PCM112121-0951	458.51	1.57	76.36
PCM112121-0905	517.15	2.01	69.48

这些因素采用的总体框架为环保产品声明 (EPD), 该声明可量化“产品生命周期的环保信息, 并对相同功能的产品进行对比” (ISO, 2006)。在遵循该框架的同时, 对从原材料到制造的整个产品阶段 (A1-A3) 应用生命周期评估法。

## Kompan A/S

C.F. Tietgens Boulevard 32C  
DK-5220 Odense SØ  
Denmark



## Verification of CO<sub>2</sub> calculation of: Play systems



Data version no. 2023-10-05

The CO<sub>2</sub> calculation and data are in compliance with the principles of a carbon footprint impact according to the GHG protocol (Greenhouse Gas Protocol), Scope 3, cradle to gate related to all individual components in the product category: "Play systems" represented by item no.: PCM200321-0950.

(Scope 3 emissions include emission sources in the upstream and downstream value chain).

**Date: 30. October 2023 | Valid until: 30. October 2025**

Verified by:

Julie Marie Vejsgaard Larsen, LCA & EPD Consultant

Verification based on report: Validation of CO<sub>2</sub> calculation of 9 categories of Kompan product line, version 1.0, prepared by: Bureau Veritas HSE, Denmark: Julie M. V. Larsen.

**Publication date: 30. October 2023**

By Bureau Veritas HSE  
www.bureauveritas.dk  
+45 7731 1000



# Play Tower with Bars

PCM112121

最大跌落高度 | 总高度 | 安全区域

最大跌落高度 | 总高度

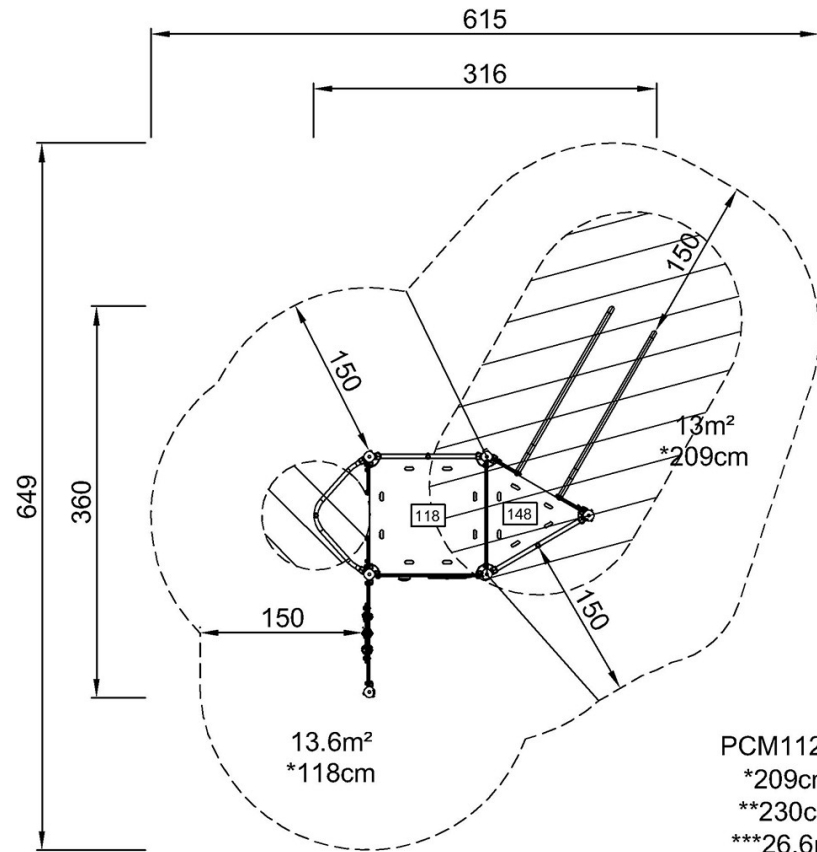

PCM112121  
\*209cm  
\*\*230cm  
\*\*\*26.6m<sup>2</sup>

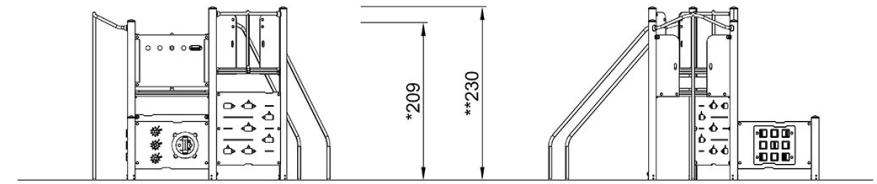

PCM112121

[点击查看俯视图](#)

[点击查看侧面图](#)