

# Fitness Jumper Flex

FSW235

**KOMPAN**  
Let's play

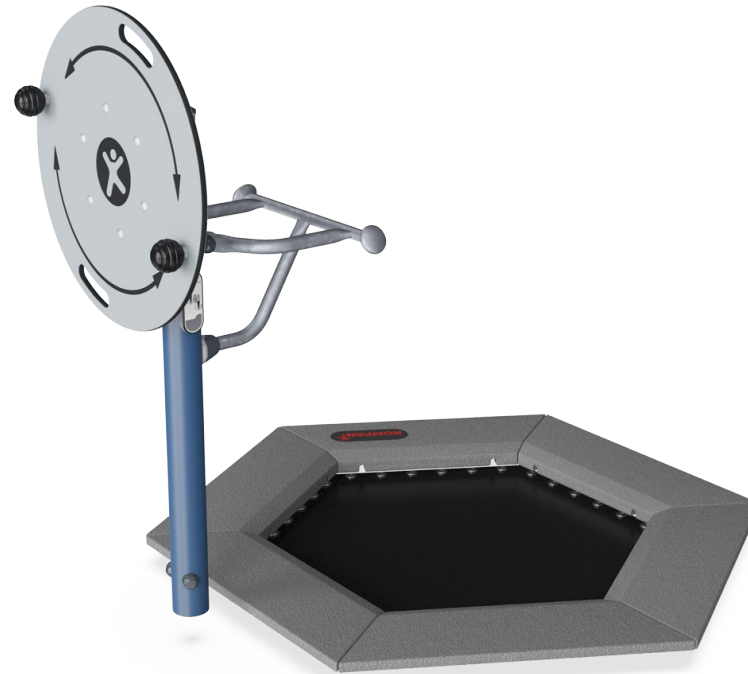

|                                    |                |
|------------------------------------|----------------|
| Item no. FSW23500-0902             |                |
| <b>General Product Information</b> |                |
| Dimensions LxWxH                   | 192x208x140 cm |
| Age group                          | 13+            |
| Play capacity (users)              | 2              |
| Color options                      |                |



See KOMPAN Fit app for more



The Flex Wheel is simple to use and requires little experience beforehand. The turning movement has a mild resistance suitable for users at all levels. The ergonomically designed handles allow for natural wrist position and gives the user the opportunity to do exercises from multiple positions. The wheel will train shoulder and upper body mobility. For really

challenging exercises it can be used standing on one foot using one hand – either front facing or sideways. Exercising on a KOMPAN Fitness Jumper gives an intense cardiovascular workout, you train your balance and improve your bone density. The Fitness Jumper challenges both the experienced fitness jumper athlete and the

average fitness enthusiast.

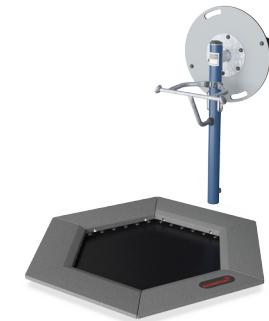

# Fitness Jumper Flex

FSW235

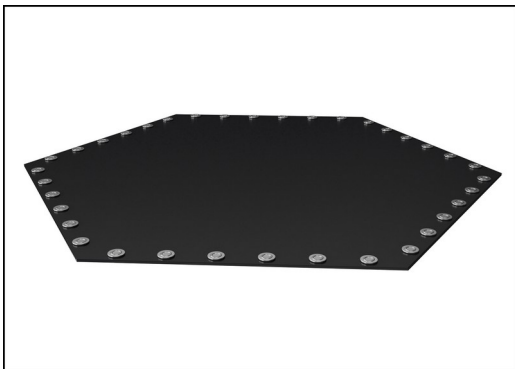

The jumping membranes are made of 6,0mm thick EP Ethylene-Propylene conveyor belt with polyester polyamide fabric carcass. Spring fixations are reinforced with steel bushings and washers on both sides. The membrane is ozone resistant and equipped with 8 center placed water drain holes.

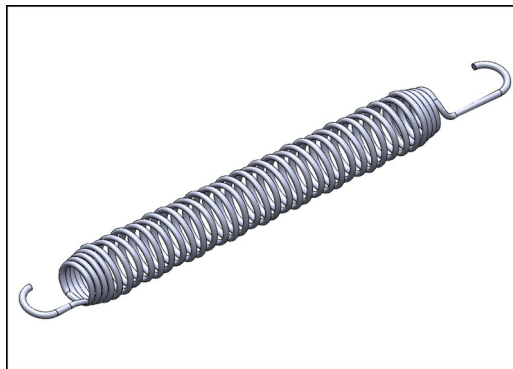

All 36 springs are made of stainless steel to ensure durability and excellent corrosion resistance. The steel wire is 3,2 mm thick and the last five windings are cone shaped to ensure long lifetime of the jumper.

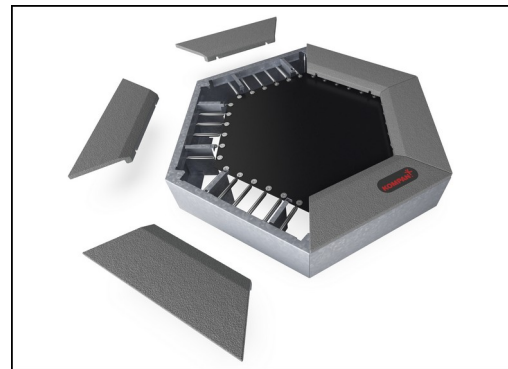

As a unique feature the SBR tiles can be removed for cleaning and service. By loosening six screws the SBR tile can be lifted up to open and gain access to the springs (see instruction on KOMPAN Master).

Item no. FSW23500-0902

### Installation Information

|                          |                     |
|--------------------------|---------------------|
| Max. fall height         | 100 cm              |
| Safety surfacing area    | 16.3 m <sup>2</sup> |
| Total installation time  | 5.9                 |
| Excavation volume        | 1.15 m <sup>3</sup> |
| Concrete volume          | 1.02 m <sup>3</sup> |
| Footing depth (standard) | 90 cm               |
| Shipment weight          | 408 kg              |
| Anchoring options        |                     |



The ball grips are ø80mm and are made from black, vacuum formed polycarbonate (PC). Polycarbonate is extremely strong and can withstand a very high impact.



The bearing house is made from hot dip galvanised steel. The bearing shaft is made from stainless steel AISI304. The bearing itself is made from Polyoxymethylene (POM), an engineering thermoplastic with a high stiffness, low friction, and excellent dimensional stability.



The ø80x19mm wheel is made from HDPE EcoCore™ plate. EcoCore™ is a highly durable, ecofriendly material, which is not only recyclable after use, but is also made of +95% recycled post-consumer material from e.g., food packing waste in both core and colorful outer layer.



# Sustainability Data

FSW235

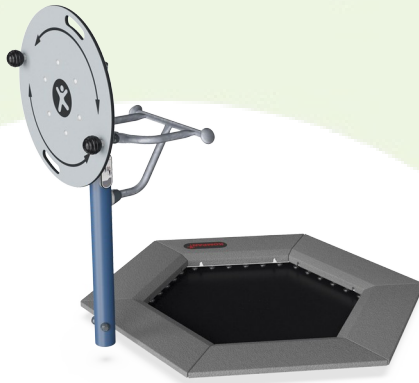

| Cradle to Gate A1-A3 | Total CO <sub>2</sub> emission | CO <sub>2</sub> e/kg    | Recycled materials |
|----------------------|--------------------------------|-------------------------|--------------------|
|                      | kg CO <sub>2</sub> e           | kg CO <sub>2</sub> e/kg | %                  |
| <b>FSW23500-0902</b> | 476.80                         | 2.17                    | 60.00              |

The overall framework applied for these factors is the Environmental Product Declaration (EPD), which quantifies "environmental information on the life cycle of a product and enable comparisons between products fulfilling the same function" (ISO, 2006). This follows the structure and applies a Life-Cycle Assessment approach to the entire Product stage from raw material through manufacturing (A1-A3))

**Kompan A/S**  
 C.F. Tietgens Boulevard 32C  
 DK-5220 Odense SØ  
 Denmark



## Verification of CO<sub>2</sub> calculation of: Fitness



Data version no. 2023-10-05

The CO<sub>2</sub> calculation and data are in compliance with the principles of a carbon footprint impact according to the GHG protocol (Greenhouse Gas Protocol), Scope 3, cradle to gate related to all individual components in the product category: "Fitness" represented by item no.: FAZ10100-0900.

(Scope 3 emissions include emission sources in the upstream and downstream value chain).

**Date: 30. October 2023 | Valid until: 30. October 2025**

**Verified by:**

Julie Marie Vejsgaard Larsen, LCA & EPD Consultant

Verification based on report: Validation of CO<sub>2</sub> calculation of 9 categories of Kompan product line, version 1.0, prepared by: Bureau Veritas HSE, Denmark: Julie M. V. Larsen.

**Publication date: 30. October 2023**

**By Bureau Veritas HSE**  
 www.bureauveritas.dk  
 +45 7731 1000



# Fitness Jumper Flex

FSW235

\* Max fall height | \*\* Total height | \*\*\* Safety surfacing area

\* Max fall height | \*\* Total height

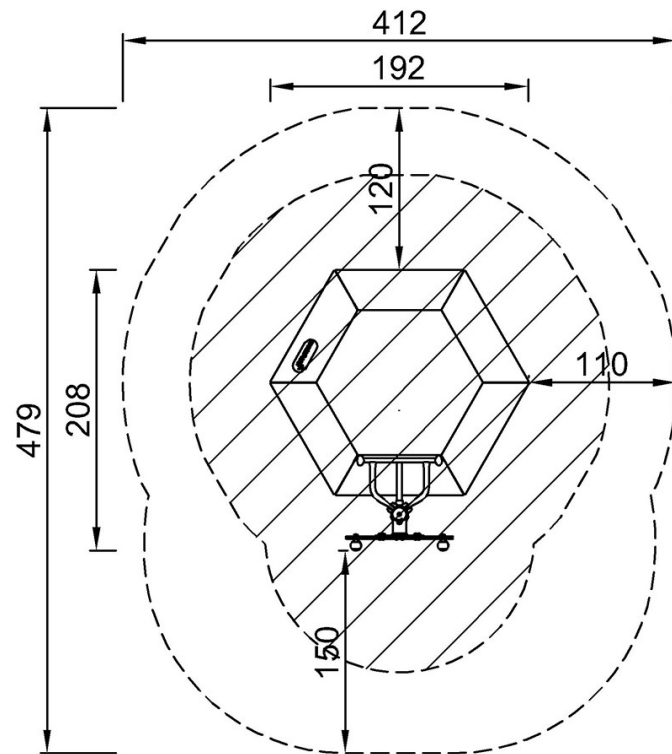

FSW23500  
\*100cm  
\*\*140cm  
\*\*\*16.3m<sup>2</sup>

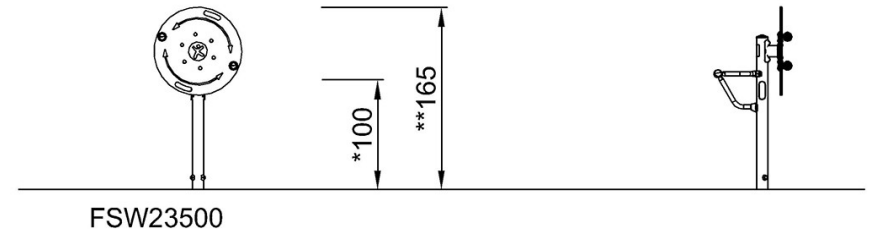

[Click to see TOP VIEW](#)

[Click to see SIDE VIEW](#)