

Service & Workshop

MSV602



The Service & Workshop is a wildly at-tractive play universe for infants and toddlers. It is loaded with play possibilities and children play intensely, again and again. Infants and toddlers explore, using the structure as support for raising, crawling and walking around. Numerous play features motivate social play and support child development. The Stop-Go

sign, the gears and strings unite children that way. The Workshop side has tangible themes: gearing and steering wheels and microphone. The Service side has pressure measurer and bell. The pushing, pulling and investigation of the numerous manipulative play items stimulate the child's logical thinking skills. The rich themes inspire dramatic play, which is

phenomenal for language development – a main factor for learning, friendship-building and life success.

Item no. MSV60200-0201	
General Product Information	
Dimensions LxWxH	147x120x121 cm
Age group	6m+
Play capacity (users)	8
Colour options	

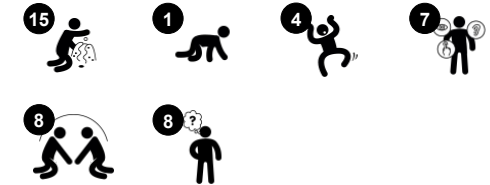

Service & Workshop

MSV602



String with knobs

Social-Emotional: turn-taking and cooperation are supported when pulling the string from side to side with friends or caregiver. **Cognitive:** an understanding of object permanence is supported when the knob disappears and reappears when pulled. **Creative:** leaving the knob in different positions can support symbolic and creative thinking.

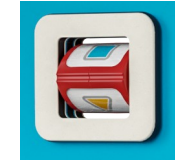

Tumbler

Social-Emotional: cooperation skills and turn-taking are supported when turning the tumbler from each side of the panel. **Cognitive:** cause and effect understanding for toddlers when spinning the tumbler.



Microphone

Cognitive: inspires dramatic play which stimulates language development. Cause and effect understanding is supported when discovering that the microphone can be shifted to different positions. **Creative:** positioning the microphone in different positions can support symbolic thinking.



Funnel

Social-Emotional: trains cooperation and turn-taking as children put materials into the funnel. **Cognitive:** the passing of materials through funnels supports the children's logical thinking and for younger children the understanding of object permanence: that materials don't vanish but run through at the other end.

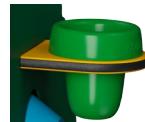

Pot

Cognitive: the pot can be removed, stimulating cause and effect understanding. Filling and emptying the pot stimulates logical thinking and the understanding of concepts such as empty and full. **Creative:** placing the pot in other areas of the play space in creative ways can support symbolic and creative thinking.



Gear wheels

Social-Emotional: cooperation skills and turn-taking are supported when turning the gear wheel. **Cognitive:** cause and effect understanding and logical thinking are supported when turning the vertical gear to make the horizontal gear run.



Bell

Cognitive: understanding cause and effect when ringing bell. **Creative:** leaving a mark in creating a sound rhythm when ringing or knocking the bell.

Service & Workshop

MSV602



Panels of 19mm EcoCore™. EcoCore™ is a highly durable, eco friendly material, which is not only recyclable after use, but also consists of material produced from +95% recycled post consumer material from food packing waste.



Corocord membranes consist of friction-proof rubberized material of conveyor belt quality with excellent UV resistance. Tested and compliant with REACH requirements for PAH. Embedded is a four-layered armouring made of woven polyester. The armouring and the two surface layers result in a total thickness of 7.5 mm.

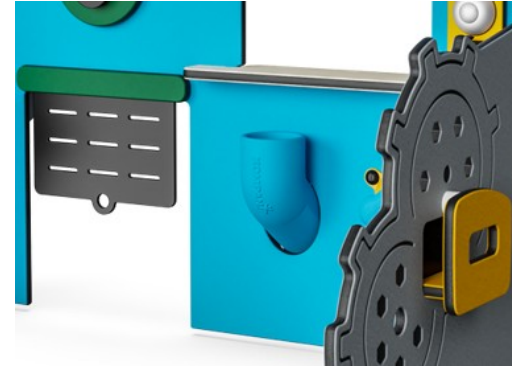

Sand Pipe is made with 33% post-consumer materials in different colors in one-piece design with a wall thickness of minimum 5mm. Material in accordance with the European Standard EN 71-3 and tested for UV stability.



Pots are made of pressure moulded high quality nylon (PA6). PA6 has good wearing and impact strength.

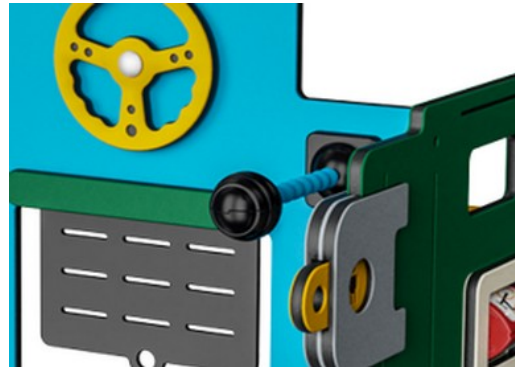

Microphone is made of PC and fitted on a flexible shaft of POM material.

Item no. MSV60200-0201

Installation Information

Max. fall height	0 cm
Safety surfacing area	15.1 m ²
Total installation time	6.1
Excavation volume	0.00 m ³
Concrete volume	0.00 m ³
Footing depth (standard)	0 cm
Shipment weight	52 kg
Anchoring options	Surface ✓

Warranty Information

EcoCore HDPE	Lifetime
Membrane	2 years
Movable parts	2 years
PUR components	10 years
Spare parts guaranteed	10 years



Sustainability Data

MSV602

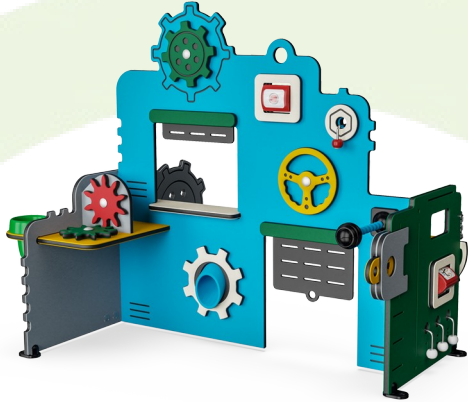

Cradle to Gate A1-A3	Total CO ₂ emission	CO ₂ e/kg	Recycled materials
	kg CO ₂ e	kg CO ₂ e/kg	%
MSV60200-0201	55.80	1.13	85.74

The overall framework applied for these factors is the Environmental Product Declaration (EPD), which quantifies "environmental information on the life cycle of a product and enable comparisons between products fulfilling the same function" (ISO, 2006). This follows the structure and applies a Life-Cycle Assessment approach to the entire Product stage from raw material through manufacturing (A1-A3))

Kompan A/S
 C.F. Tietgens Boulevard 32C
 DK-5220 Odense SØ
 Denmark



Verification of CO₂ calculation of: Themed play systems



Data version no. 2023-10-05

The CO₂ calculation and data are in compliance with the principles of a carbon footprint impact according to the GHG protocol (Greenhouse Gas Protocol), Scope 3, cradle to gate related to all individual components in the product category: "Themed play systems" represented by item no.: MSC641100-3717P.

(Scope 3 emissions include emission sources in the upstream and downstream value chain).

Date: 30. October 2023 | Valid until: 30. October 2025

Verified by:

Julie Marie Vejsgaard Larsen, LCA & EPD Consultant

Verification based on report: Validation of CO₂ calculation of 9 categories of Kompan product line, version 1.0, prepared by: Bureau Veritas HSE, Denmark: Julie M. V. Larsen.

Publication date: 30. October 2023

By Bureau Veritas HSE
 www.bureauveritas.dk
 +45 7731 1000



Service & Workshop

MSV602

* Max fall height | ** Total height | *** Safety surfacing area

* Max fall height | ** Total height

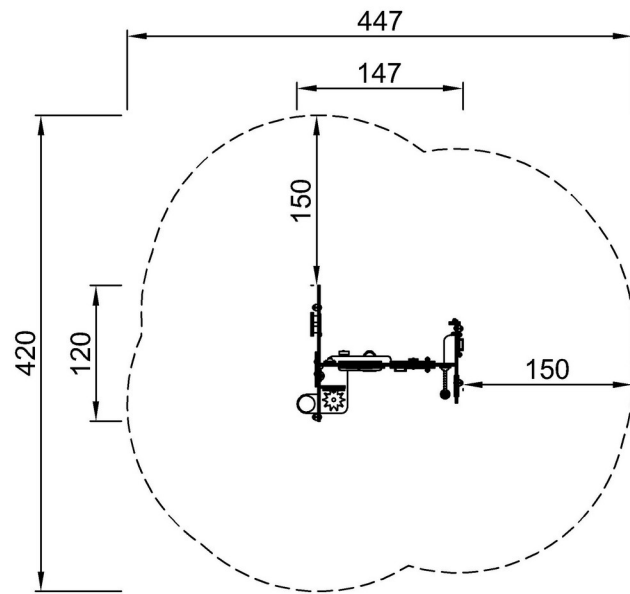

MSV60200-0201

**121cm
***15.1m²



MSV60200-0201

[Click to see TOP VIEW](#)

[Click to see SIDE VIEW](#)