

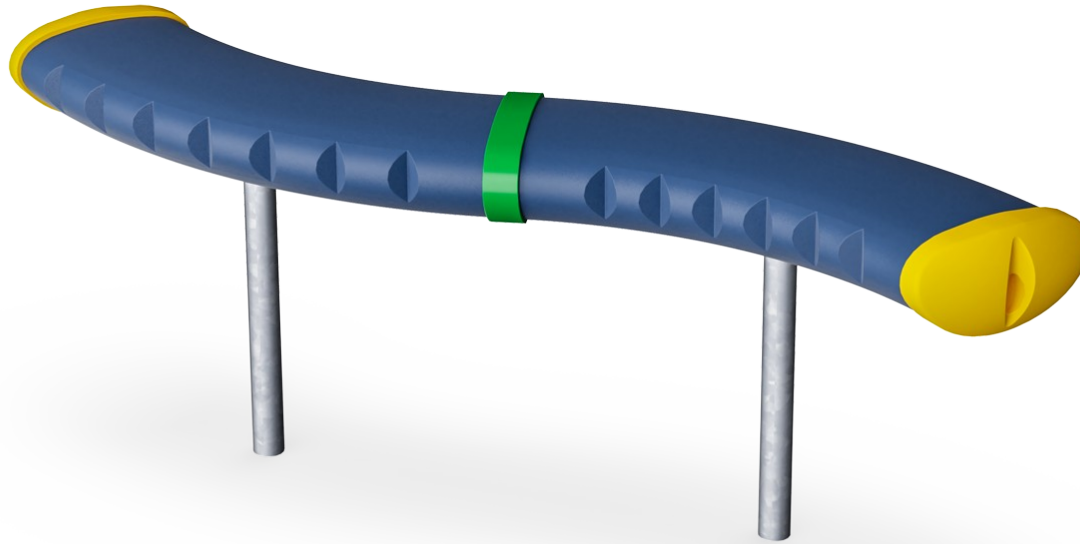

Bench S 60cm

FRE3013



Item no. FRE3013-3417	
General Product Information	
Dimensions LxWxH	147x96x61 cm
Age group	3+
Play capacity (users)	-
Color options	

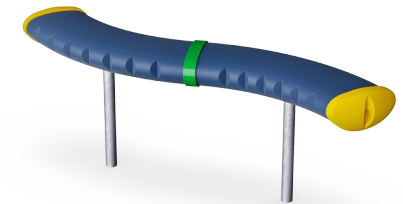

The curved benches can be installed in different heights and next to each other to create a tribune. The benches are splendid meeting points to socialise with friends and look at sport activities at the same time.



Bench S 60cm

FRE3013

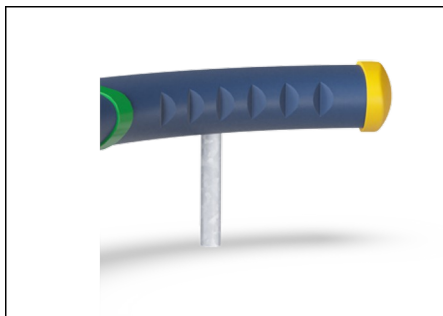

The steel surfaces are hot dip galvanised inside and outside with lead free zinc. The galvanisation has excellent corrosion resistance in outside environments and requires low maintenance.

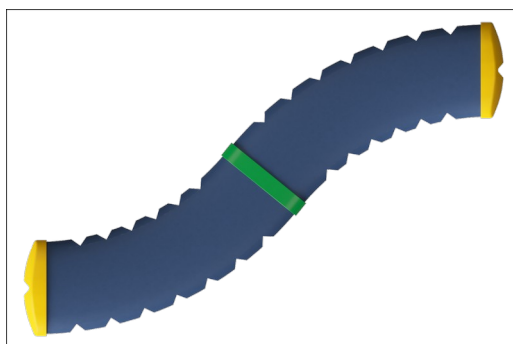

The large components are made of 100% recyclable PE made from 33% post consumer materials. Molded in one piece with minimum 5mm wall thickness to ensure high durability in all climates around the world.



KOMPAN GreenLine versions are designed with ultimate environmentally friendly materials with lowest possible CO2e emission factor such as EcoCore™ panels of +95% post consumer recycled ocean waste.

Item no. FRE3013-3417

Installation Information

Max. fall height	0 cm
Safety surfacing area	0.0 m ²
Total installation time	1.9
Excavation volume	0.29 m ³
Concrete volume	0.10 m ³
Footing depth (standard)	60 cm
Shipment weight	32 kg
Anchoring options	In-ground ✓ Surface ✓

Warranty Information

Hollow PE parts	10 years
Hot dip galvanised steel	Lifetime
Spare parts guaranteed	10 years



Sustainability Data

FRE3013

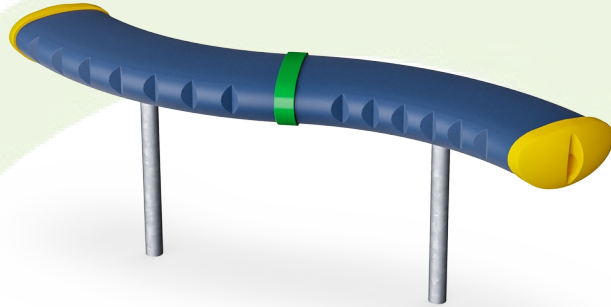

Cradle to Gate A1-A3	Total CO ₂ emission	CO ₂ e/kg	Recycled materials
	kg CO ₂ e	kg CO ₂ e/kg	%
FRE3013-3417	73.13	2.28	34.61

The overall framework applied for these factors is the Environmental Product Declaration (EPD), which quantifies "environmental information on the life cycle of a product and enable comparisons between products fulfilling the same function" (ISO, 2006). This follows the structure and applies a Life-Cycle Assessment approach to the entire Product stage from raw material through manufacturing (A1-A3))

Kompan A/S
C.F. Tietgens Boulevard 32C
DK-5220 Odense SØ
Denmark



Verification of CO₂ calculation of: Park



Data version no. 2023-10-05

The CO₂ calculation and data are in compliance with the principles of a carbon footprint impact according to the GHG protocol (Greenhouse Gas Protocol), Scope 3, cradle to gate related to all individual components in the product category: "Park" represented by item no.: PAR4070-0001.

(Scope 3 emissions include emission sources in the upstream and downstream value chain).

Date: 30. October 2023 | Valid until: 30. October 2025

Verified by:

Julie Marie Vejsgaard Larsen, LCA & EPD Consultant

Verification based on report: Validation of CO₂ calculation of 9 categories of Kompan product line, version 1.0, prepared by: Bureau Veritas HSE, Denmark: Julie M. V. Larsen.

Publication date: 30. October 2023

By Bureau Veritas HSE
www.bureauveritas.dk
+45 7731 1000



Bench S 60cm

FRE3013

* Max fall height | ** Total height | *** Safety surfacing area

* Max fall height | ** Total height

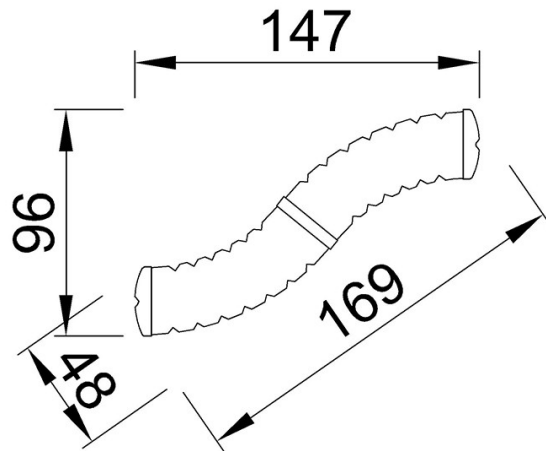

FRE3013
**61cm



FRE3013

[Click to see TOP VIEW](#)

[Click to see SIDE VIEW](#)