

# Bench C 40cm

FRE3010

**KOMPANI**  
Let's play

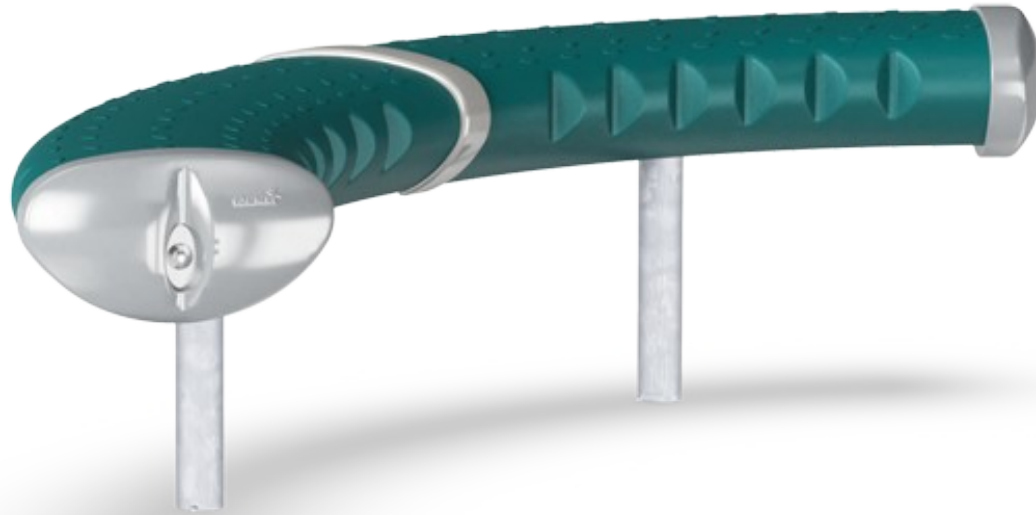

产品编号 FRE3010-3417DT

## 产品信息概览

长宽高尺寸	127x108x41 cm
适用年龄段	3+
容纳人数	-
颜色选择	

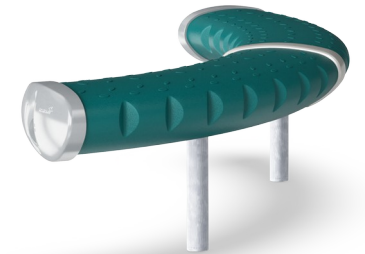

弧形的 Benches 可以安装在不同高度，也可以相邻安装，形成一个护栏。它是一个绝佳的聚会点，孩子们既能与朋友们进行社交，又能同时观看体育活动。



# Bench C 40cm

FRE3010

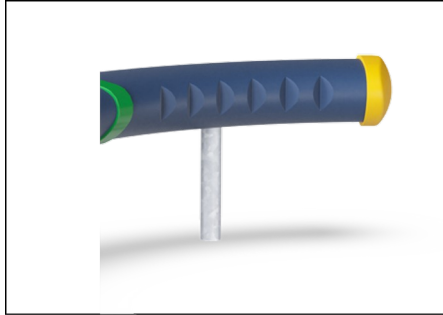

钢表面内外均采用无铅热镀锌镀层，户外耐蚀性高，维护成本低。

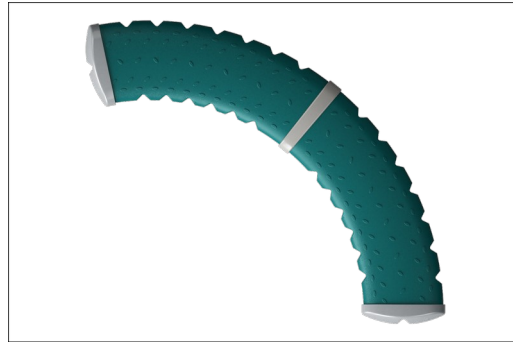

The large components are made of 100% recyclable PE made from 33% post consumer materials. Molded in one piece with minimum 5mm wall thickness to ensure high durability in all climates around the world.

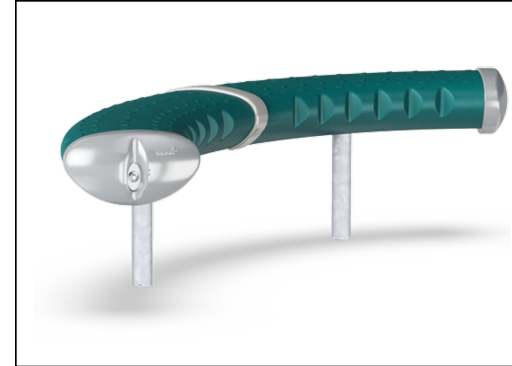

KOMPAN 环保系列产品采用终极环保材料设计，具有将二氧化碳排放当量系数降至最低的可能性。如 100% 消费后的海洋可循环材料制成的 EcoCore™ 面板。

产品编号 FRE3010-3417DT

## 安装信息

最大跌落高度	0 cm
安全面积	0.0 m <sup>2</sup>
安装总时长	1.9
开挖量	0.29 m <sup>3</sup>
混凝土使用量	0.10 m <sup>3</sup>
标准入地深度	60 cm
运输重量	31 kg
固定选项	入地 ✓ 地表 ✓

## 质保信息

中空 PE 聚乙烯部件	10 年
镀锌钢结构	终身质保
承保零部件	10 年



# Sustainability Data

FRE3010

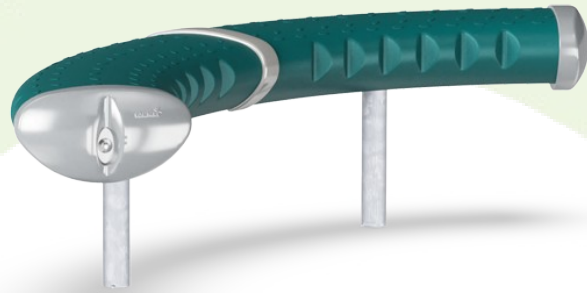

从原材料到成品	CO <sub>2</sub> 排放总量	CO <sub>2</sub> 排放量 / 千克	回收的原料
	kg CO <sub>2</sub> e	kg CO <sub>2</sub> e/kg	%
<b>FRE3010-3417DT</b>	68.52	2.26	33.69

这些因素采用的总体框架为环保产品声明 (EPD), 该声明可量化“产品生命周期的环保信息, 并对相同功能的产品进行对比” (ISO, 2006)。在遵循该框架的同时, 对从原材料到制造的整个产品阶段 (A1-A3) 应用生命周期评估法。

## Kompan A/S

C.F. Tietgens Boulevard 32C  
DK-5220 Odense SØ  
Denmark

Validation of CO<sub>2</sub>  
calculation method  
**BUREAU VERITAS**  
HSE Denmark A/S



## Verification of CO<sub>2</sub> calculation of: Park



Data version no. 2023-10-05

The CO<sub>2</sub> calculation and data are in compliance with the principles of a carbon footprint impact according to the GHG protocol (Greenhouse Gas Protocol), Scope 3, cradle to gate related to all individual components in the product category: "Park" represented by item no.: PAR4070-0001.

(Scope 3 emissions include emission sources in the upstream and downstream value chain).

**Date: 30. October 2023 | Valid until: 30. October 2025**

Verified by:

Julie Marie Vejsgaard Larsen, LCA & EPD Consultant

Verification based on report: Validation of CO<sub>2</sub> calculation of 9 categories of Kompan product line, version 1.0, prepared by: Bureau Veritas HSE, Denmark: Julie M. V. Larsen.

**Publication date: 30. October 2023**

By Bureau Veritas HSE  
www.bureauveritas.dk  
+45 7731 1000



# Bench C 40cm

FRE3010

最大跌落高度 | 总高度 | 安全区域

最大跌落高度 | 总高度

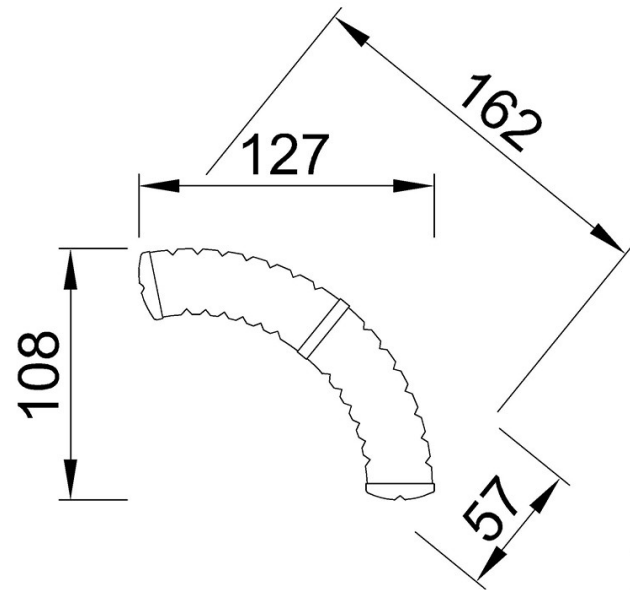

FRE3010  
\*\*41cm

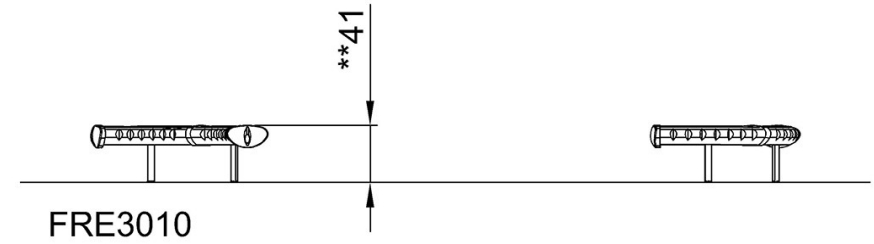

[点击查看俯视图](#)

[点击查看侧面图](#)